



METER

HYPROP 2



TABLE OF CONTENTS

1. Introduction	1
1.1 HYPROP Complete Set	1
1.2 HYPROP Extension Set	2
1.3 HYPROP Starter Set	2
2. Operation	3
2.1 Installation	3
2.2 Hyprop Measurement Process	5
2.3 Soil Sample Preparation	7
2.3.1 Undisturbed Soil Sample	7
2.3.2 Disturbed Soil Sample	10
2.4 Saturate Soil Sample	11
2.5 Device Preparation: Tensiometer shafts, HYPROP Sensor Unit, and LABROS Balance	16
2.5.1 Tensiometer Shafts	16
2.5.2 Using the refill unit	16
2.5.3 Using Syringes	18
2.5.4 Offset Recalibration	31
2.5.5 Implementing Tensiometer Shafts in Sensor Unit	34
2.5.6 HYPROP Sensor Unit and Soil Sample	41
2.5.7 LABROS Balance	43
2.6 HYPROP Measurement Modes	45
2.6.1 Measuring with Multi-balance Mode	45
2.6.2 Measuring with Single-balance Mode	50
2.6.3 Weighing the Sample	54
2.6.4 Configure HYPROP Profile	55

2.6.5	Optimal Measurement Curve	59
2.6.6	Suboptimal Measurement Curve	60
2.6.7	Finishing a Measurement.....	61
2.7	Postprocessing	65
2.7.1	Extension of the Measurement Range	65
2.7.2	Determining Dry Soil Weight	65
2.7.3	Disassembling and Cleaning	66
2.8	Data Evaluation and Export	68
3.	System.....	69
3.1	Specifications.....	69
3.2	Components	71
3.2.1	LED Indicator	73
3.2.2	Change Device Identification (ID)	73
3.2.3	Tube Connections.....	75
3.2.4	Additional Functions of LABROS SoilView Software	76
3.2.5	Continue a Measurement after Stopped or Completed	76
3.3	Theory.....	77
3.3.1	Measuring Method	78
3.3.2	Generating Data Points	80
3.3.3	Additional Notes	82
4.	Service.....	84
4.1	Calibration	84
4.2	Cleaning and Maintenance.....	84
4.2.1	Changing the O-ring in the Sensor Unit	84
4.2.2	Storage	86
4.3	Troubleshooting	86
4.4	Customer Support.....	88
4.5	Terms and Conditions	88

APPENDIX A. Determining Air Entry Value89

APPENDIX B. Example Measurement Results91

APPENDIX C. WP4C Use After HYPROP99

APPENDIX D. Measuring Units 104

References 105

Index 107

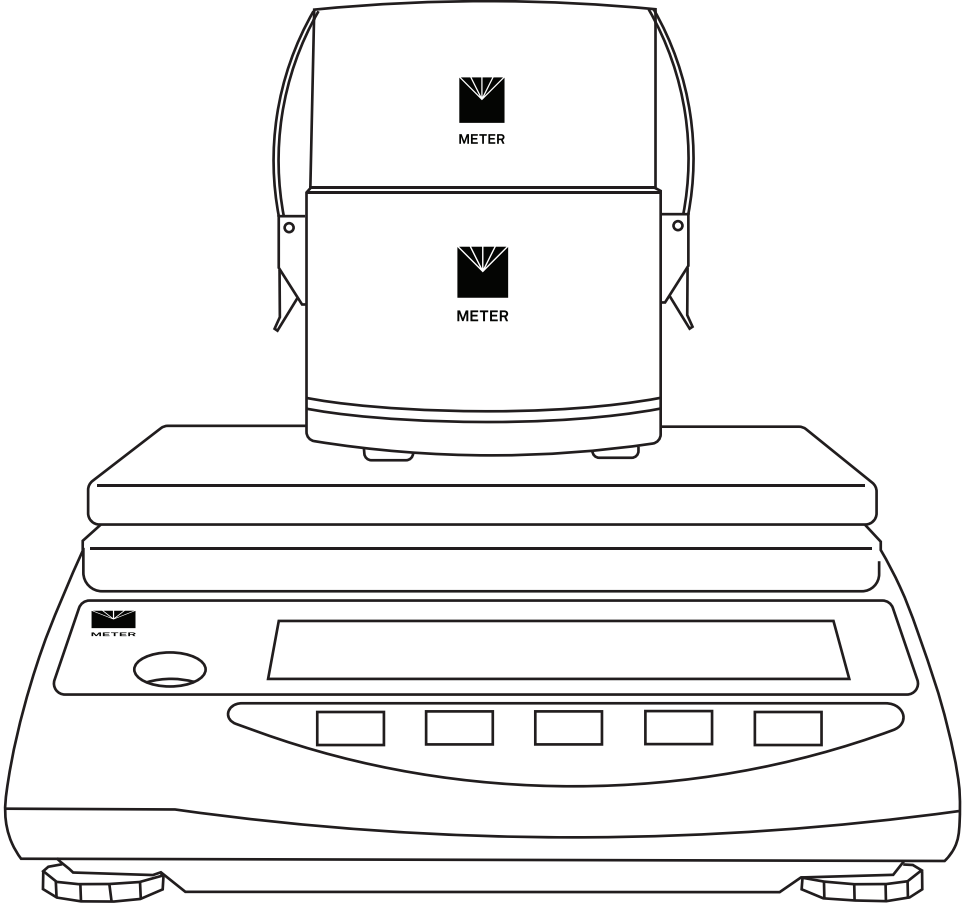

1. INTRODUCTION

Thank you for choosing the HYPROP 2® sensor from METER Group.

This manual includes detailed information about preparing, measuring, and postprocessing of soil samples as well as information about the theory behind the HYPROP. This manual also includes LABROS SoilView Software configuration instructions.

HYPROP is a measuring system intended for measuring the water retention function and the hydraulic conductivity as a function of the water tension and water content of soil samples.

METER Group GmbH offers a warranty for material and production defects for this device in accordance with locally applicable legal provisions for a maximum of 12 months. The warranty does not cover damage caused by misuse, unauthorized servicing or circumstances beyond our control. The warranty includes replacement or repair and packing but excludes shipping expenses. Please contact METER or our representative before returning equipment. Place of fulfillment is Mettlacher Straße 8, Munich, Germany.

Prior to use, verify the sensor arrived in good condition.

1.1 HYPROP COMPLETE SET

The Complete Set provides all equipment needed to fully utilize the HYPROP 2. The following items are included in the Complete Set:

- 1 droplet syringe
- 3 vacuum syringes
- 2 reservoir syringes
- 1 tensiometer shaft auger
- 1 tube for vacuum syringe and refilling adapter
- 1 auger guide
- 1 METER soil sampling ring with lids
- Deionized water
- 1 HYPROP USB adapter
- 1 power device
- 1 HYPROP sensor unit
- Tensiometer shafts, 1 50-mm and 1 25-mm
- 1 Saturation plate
- 1 Refilling adapter
- 1 HYPROP connecting cable
- 1 Silicone gasket and nonwoven cloth

- 1 TensioLink T-piece
- 2 Plastic caps
- 1 set of O-rings
- 1 LABROS Balance

1.2 HYPROP EXTENSION SET

The Extension Set does not include the LABROS Balance and is recommended for labs with an existing balance. The following items are included in the Extension Set:

- 1 HYPROP Sensor Unit
- Tensiometer shafts 1 50-mm and 1 25-mm
- 1 Saturation plate
- 1 Refilling adapter
- 1 HYPROP connecting cable
- 1 Silicone gasket and nonwoven cloths
- 1 tensioLink T-piece
- 2 Plastic caps
- 1 set O-rings

1.3 HYPROP STARTER SET

The Starter Set does not include the LABROS Balance or saturation plate. The following items are included in the Starter Set:

- 1 Droplet syringe
- 3 Vacuum syringes
- 2 Reservoir syringes
- 1 Tensiometer shaft auger
- 1 Tube for vacuum syringe and refilling adapter
- 1 Auger guide
- 1 METER Soil sampling ring with lids
- Deionized water
- 1 HYPROP USB adapter
- 1 Power device

Prior to use, verify the HYPROP and accessories arrived in good condition.

NOTE: Throughout this manual LABROS Balance or balance is used. Both refer to or include the HYPROP Balance, an older version of the LABROS Balance.

2. OPERATION

Please read all instructions before operating the HYPROP to ensure it performs to its full potential.

PRECAUTION

METER sensors are built to the highest standards, but misuse, improper protection, or improper installation may damage the sensor and possibly void the manufacturer's warranty. Before integrating HYPROP 2 into a system, make sure to follow the recommended installation instructions and have the proper protections in place to safeguard sensors from damage.

Please observe the following considerations carefully:

1. Read all applicable safety instructions.
2. Electrical installations must follow the safety and EMC requirements of the country where the system is used.

IMPORTANT: Do not use the device if the electrical wire is damaged. Always avoid direct sunlight exposure.

3. Dispose of all materials and chemicals according to national legislation and environmental care regulations.

Please refer to the respective safety data sheets.

4. Do not touch the ceramic tips of the tensiometer shafts with bare hands.
Grease or soap reduces the hydrophilic characteristics of the ceramic.
5. Do not stick sharp objects into the holes of the sensor unit.
This may damage the pressure sensors.

2.1 INSTALLATION

Follow the steps listed in [Table 1](#) to set up the HYPROP and start collecting data.

Table 1 Installation

Tools Needed	Microsoft® Windows computer (Windows 10 or newer)
Installation	<p>Install LABROS Software and METER USB Driver</p> <p>Download the Installation package (LABROS SoilView software) from https://meter.ly/hyprop-support.</p> <p>Run the LABROS SoilView *.exe file and follow the instructions on the screen of the installation assistant. Using the default settings, the software, LABROS SoilView (measurement software) and LABROS SoilView-Analysis (evaluation software), will be installed at the same time. If only one software package is desired, please select Entire feature will be unavailable in the window for the software that is not needed.</p>

Table 1 Installation (continued)

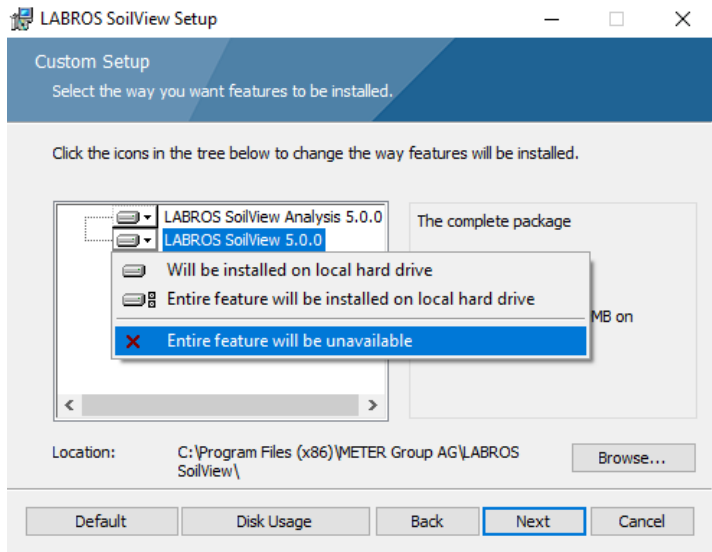
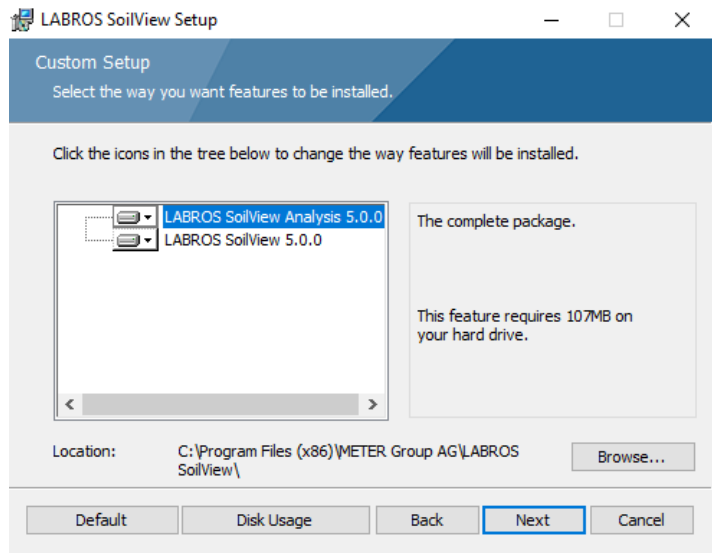
Installation
(continued)**Custom Setup Screen**

If there is a problem executing the file `HYPROP.exe` please download and install Microsoft NET Framework 4.8.0 manually and be sure to have the current version of the Windows installer.

Table 1 Installation (continued)

Installation (continued)	Click on the LABROS SoilView software icon to open the program. Icon is located where saved in the Wizard installation.	
Connecting	<p>Connect HYPROP</p> <p>Option 1</p> <p>Connect the HYPROP to a LABROS Balance that is connected to a computer USB port. The HYPROP LED should flash white three times and then turn off (Section 3.2.1).</p> <p>Multiple LABROS Balances and HYPROP's can be used simultaneously by connecting them to a powered USB hub. METER recommends a maximum of 20 balances and HYPROP's per computer.</p> <p>Option 2</p> <p>Connect the HYPROP to the tensioLink USB adapter that is connected to a computer USB port. The HYPROP LED should flash white three times and then turn off (Section 3.2.1).</p> <p>Multiple HYPROP units can be used simultaneously by connecting them to the powered tensioLink USB adapter. METER recommends a maximum of 20 HYPROP units per computer.</p>	

2.2 HYPROP MEASUREMENT PROCESS

The HYPROP measurement process is divided into five parts.

- Soil samples preparation ([Section 2.3–Section 2.4](#))
- Device preparation ([Section 2.5](#))
- HYPROP measurement modes ([Section 2.6](#))
- Postprocessing ([Section 2.7](#))
- Data evaluation and export ([Section 2.8](#))

Each part is described step-by-step throughout the manual. Refer to listed section number to go directly to one of the five parts of using the HYPROP.

[Figure 1](#) describes all necessary steps for a complete HYPROP measurement including sample and device preparation as well as measurement and postprocessing steps.

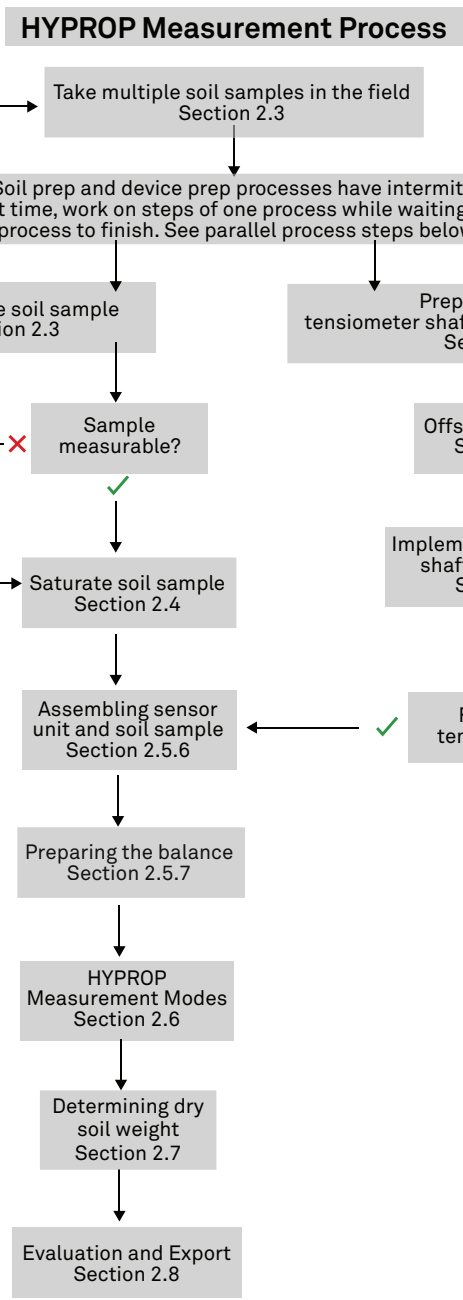

Figure 1 HYPROP measurement flow chart

2.3 SOIL SAMPLE PREPARATION

There are two methods for preparing a soil sample.

In both cases, it is important that the sample ring is full and the soil surface is flush with the top and bottom of the sample ring. All calculations are based on the exact volume of the sample ring.

A serial number is laser etched on the sample ring so it can be assigned to the respective measurement. The weight of the sample ring measured to one decimal place is also laser etched on the sample ring and represents the precise tare weight.

If soil samples are already gathered from the field and prepared, skip to [Section 2.4](#).

2.3.1 UNDISTURBED SOIL SAMPLE

The first option uses an undisturbed soil sample transferred from the field so the measured parameters can be transferred from and be representative of the respective field site. This makes it important to take the soil sample with as little disturbance and change in soil structure as possible.

METER recommends using METER soil sample rings because the highly polished stainless steel surface minimizes friction and soil disturbance. The soil remains intact and air pockets are reduced. The LABROS Balance is able to weigh as much as 2,200 g. If a larger sample ring is used, it could end up weighing more than the balance can measure.

The tools needed to collect an undisturbed soil sample are:

- Spade
- Knife
- METER soil sample ring ([Figure 2](#))
- METER hammering adapter ([Figure 2](#))
- PE hammer ([Figure 2](#))
- Transport box for moving the sample ring from the field to the lab

OPERATION

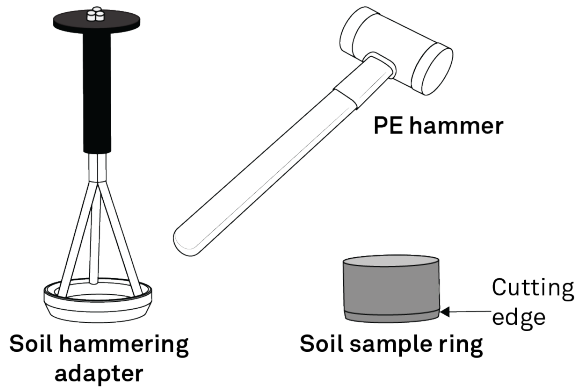

Figure 2 Soil sample tools needed

The following steps describe how to collect an undisturbed sample:

1. Cut off any vegetation to show the bare soil.
2. Dig a hole to the desired depth where the sample will be taken.
Make sure there are no large stones or roots at the selected location.
3. Place the soil sample ring with the cutting edge down on the ground.
4. Place the METER hammering adapter (available for 100 mL and 250 mL) on the sample ring (Figure 3).

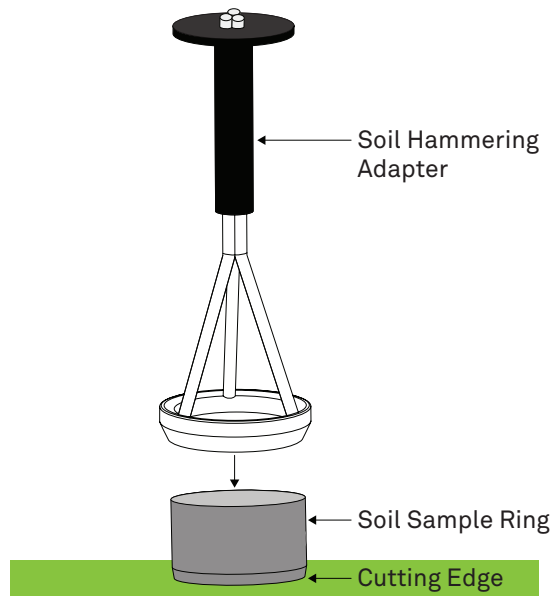

Figure 3 METER soil hammering adapter placement

- Pound on the METER hammering adapter using the recommended PE hammer until the sample ring is completely buried in the soil ([Figure 4](#)).

Make sure the sample ring goes straight down into the soil, not at an angle. Approximately 1 cm of material should protrude above the upper edge of the sample ring.

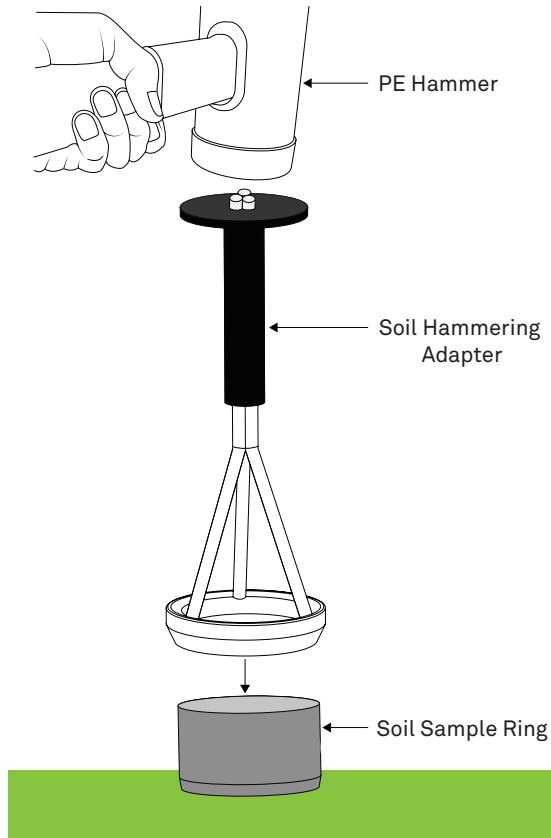

Figure 4 Pound METER hammering adapter with PE hammer to drive soil sample ring into ground

- Remove the hammering adapter.
- Use a spade to dig the sample ring out of the hole, including the undisturbed soil sample. Dig generously around the sample ring to avoid losing any sample material.

NOTE: Always take additional replacement samples from the same site in case one is not suitable.

- Remove the soil around the sample ring.
- Use a knife or scissors to cut the protruding material from the top and the bottom sides of the soil sample ring so both covers fit on each end ([Figure 5](#)).

Cut material carefully and in small amounts along the edge of the sample ring to avoid smudging the surface and closing the pores..

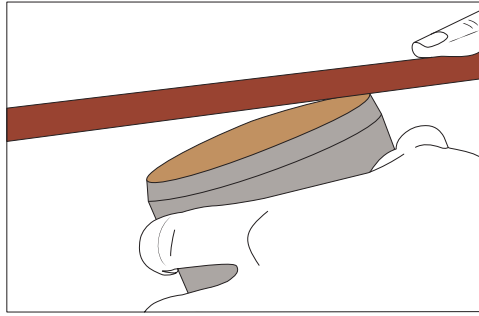

Figure 5 Level soil with top of sample ring

10. Place the sample ring with both covers on each end in the transport box.

This protects the sample from vibrations and high temperature changes. Vibrations and microbiological processes due to high temperatures may change the soil structure.

11. Take the samples out of the transport boxes and store them refrigerated.

2.3.2 DISTURBED SOIL SAMPLE

The second option uses disturbed soil material that is pressed manually into the sample ring until full.

NOTE: If a specific dry density is requested, the amount of native soil material needed to fill in the sample ring must be calculated (i.e., more than the quantity that the sample ring holds needs to be collected in order to completely fill the sample ring, even when soil has been packed to fill the sample ring).

The tools needed to collect a disturbed soil sample are listed below:

- METER soil sample ring
- fork
- knife

The following steps describe how to collect a disturbed soil sample:

1. If requested, calculate the mass of material that has to be filled in the sample ring by using the desired density as well as the water content.
2. Weigh the amount of material that has to be filled into the sample ring.
3. Fill the sample ring with material in small steps to prevent air gaps.
Use a fork or something similar to rough up the material to ensure a homogenous passage between the filled in layers.
4. Be sure that the soil sample ring is filled completely and the surface is level.
If required, cut overlapping material with a knife.
5. If no specific dry density is requested, fill the sample ring until it is completely full and the surface is flush with the soil sample ring.
If required, cut overlapping material with a knife.

6. For storage, place the two covers on the sample ring.
7. Place the soil sample ring in the refrigerator in the lab.

2.4 SATURATE SOIL SAMPLE

The next preparation step is to saturate the soil samples. The following sections explain how to properly saturate both sample types.

NOTE: If the soil sample was measured with a METER KSAT before use in the HYPROP, the sample will already be saturated. Proceed directly to [Section 2.5](#).

Gather the tools listed below prior to saturating the soil sample:

- Nonwoven cloth for filters
- LABROS Saturation plates (2)
- Weight
- Tray
- Tap water at room temperature

Follow the steps below to saturate a soil sample.

1. Take the soil sample out of the refrigerator.
2. Remove the cover on the noncutting side of the sample ring.

If soil material is protruding above the edge of the sample ring, cut off the protruding material until the surface is flush with the top of the sample ring.

Cut a little bit at a time along the edge of the sample ring and be careful not to smudge the surface and close the pores ([Figure 6](#)).



Figure 6 Cut protruding material level with edge of sample ring

OPERATION

3. Examine the noncutting side of the sample ring for irregularities such as big stones, pebbles, woody debris, roots, and intensive smell.
4. Estimate the possible lack of volume in mL attributed to the space taken up by irregularities identified in [step 3](#).

NOTE: Errors in soil volumes have a strong effect on the determined water contents in HYPROP, as in any other determination method for volumetric water contents. A volume error of 2.5 cm³ leads to a water content error of 1%. It is therefore important to ensure that the soil cores in the metal cylinders are absolutely flush with the walls of the cylinders. Overfilling and underfilling should be avoided. If they do occur, they should be estimated as precisely as possible.

Often overfilling or underfilling can be specified by a slightly altered height of the soil in the cylinder. In Power-User mode LABROS SoilView-Analysis offers the possibility to adjust the Soil Column Height (default value = 5.0 cm) in the menu Information. See [LABROS SoilView-Analysis User Manual](#) for more information.

5. Using the LABROS SoilView-Analysis software, enter the volume estimate in mL on the **Information** tab in the field provided for **Volume correction** ([Figure 7](#)).

This will affect the calculations that are based on the assumed 250 cm³ volume.

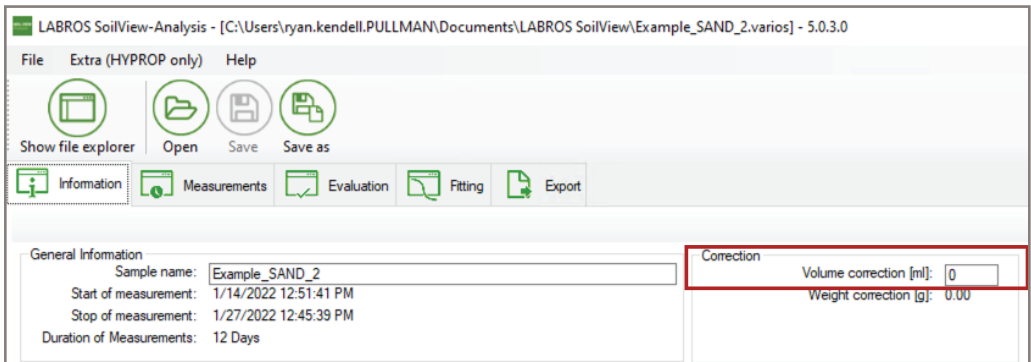

Figure 7 Volume correction in LABROS SoilView-Analysis software

6. Place one of the large filter papers on the noncutting side of the sample ring ([Figure 9](#)).
7. Place a LABROS saturation plate ([Figure 8](#)) on the noncutting side of the sample ring ([Figure 9](#)).

NOTE: The sample ring should fit snug in the LABROS saturation plate.



Figure 8 Saturation plate

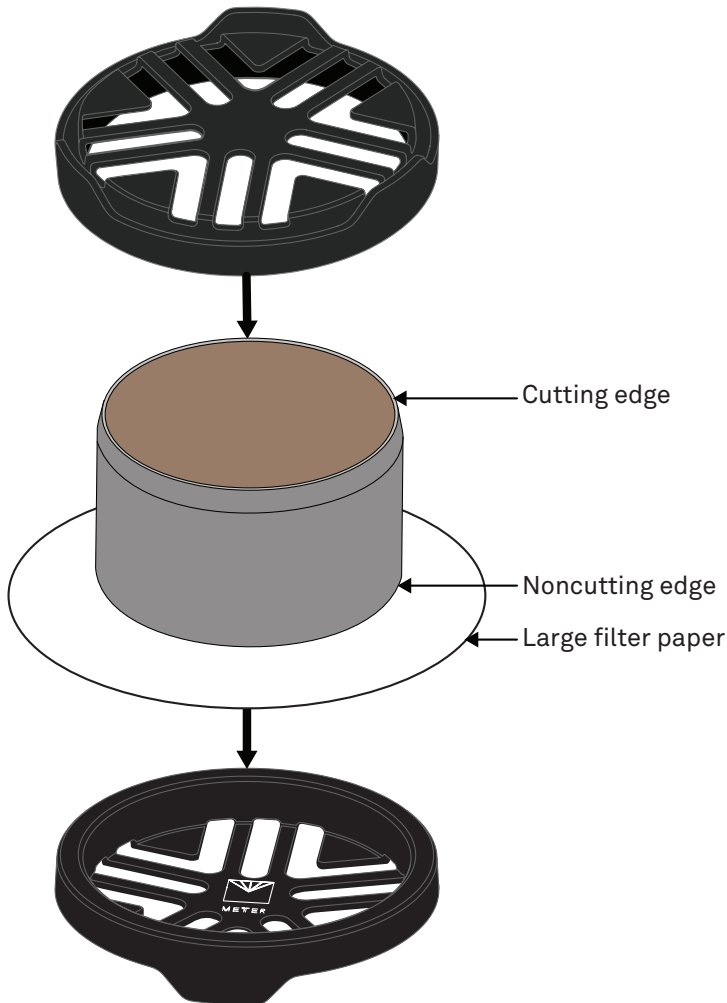

Figure 9 Large filter paper

8. Hold the filter paper and LABROS saturation plate together and turn the sample ring over so that the noncutting side is facing down.
9. Remove the cover on the cutting side of the sample ring.

If soil material is protruding above the edge of the sample ring, cut off the protruding material until the surface is flush with the top of the sample ring.

Cut a little bit at a time along the edge of the sample ring and be careful not to smudge the surface and close the pores ([Figure 10](#)).

OPERATION



Figure 10 Cut protruding soil on cutting side of sample ring

10. Repeat [step 3](#) through [step 5](#) for cutting side.
11. Place one of the small filter papers on the cutting side of the sample ring ([Figure 11](#)).

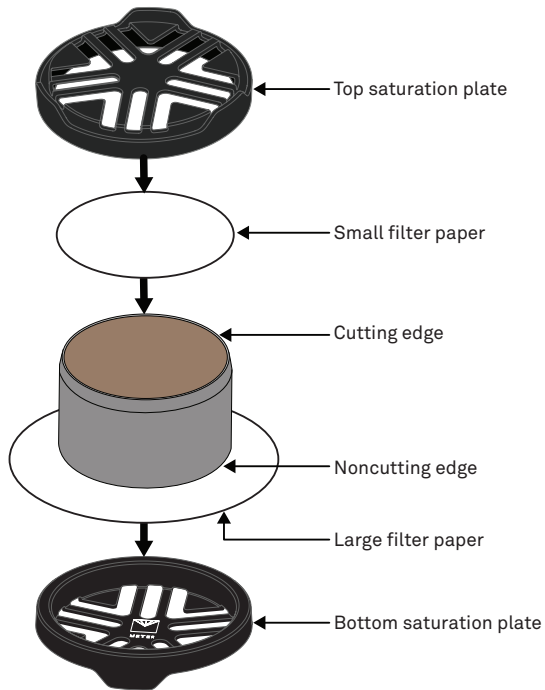

Figure 11 Large filter paper placement

12. Place the sample ring in a tray (Figure 12).

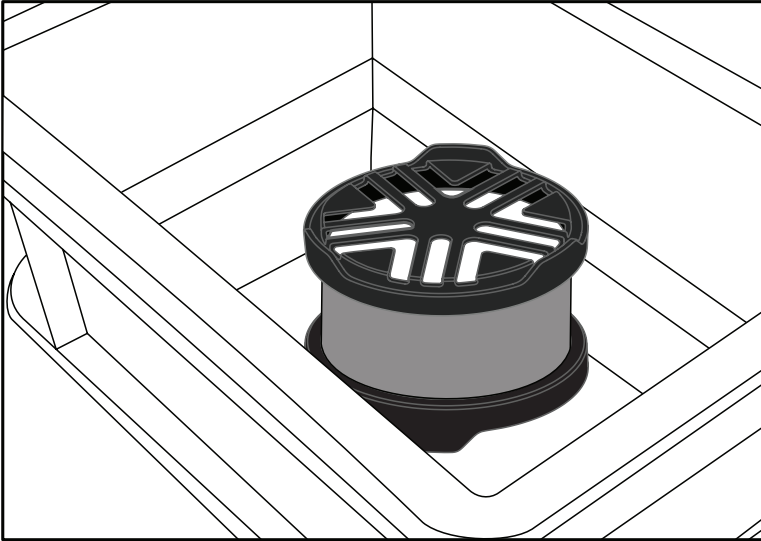

Figure 12 Saturate plate in tray

13. Fill the tray with about 3 cm of room-temperature tap water.
14. Tilt the LABROS saturation plate carefully to every side to remove air bubbles.
- IMPORTANT:** Do not pour water on the top of the sample because air becomes trapped and the pores won't completely fill with water. It is important to let the sample saturate through capillary action.
15. In case the material swells as it takes in water, place a weight on top of the sample to keep it from floating or tipping.
16. Add water up to about 1 cm from the upper edge of the sample ring after it has had time to saturate.

See [Table 2](#) for soil types and approximate time needed before adding water.

Table 2 Material times for water addition and saturation

Material	Raise Water Level After	Saturated After
Course sand	Approximately 9 min	Approximately 10 min
Fine sand	Approximately 45 min	Approximately 1 h
Silt	Approximately 6 h	Approximately 24 h
Clay	Approximately 8 h	Up to two weeks

17. Saturation is finished when the surface of the sample is glossy.

NOTE: Be sure that the tray and the soil sample are not directly exposed to sunlight.

2.5 DEVICE PREPARATION: TENSIO METER SHAFTS, HYPROP SENSOR UNIT, AND LABROS BALANCE

Device preparation is needed for the tensiometer shafts ([Section 2.5.1](#)), the HYPROP Sensor Unit and Soil Sample ([Section 2.5.6](#)), and the LABROS Balance ([Section 2.5.7](#)).

Due to the time needed for degassing the water for the Refill Unit ([Section 2.5.2](#)), or syringes if using that method ([Section 2.5.3](#)), it is recommended to begin device preparations as soon as possible once soil samples are available. Device preparation can be started while the saturation of soil samples ([Section 2.4](#)) is ongoing.

2.5.1 TENSIO METER SHAFTS

The porous ceramic tip enables the degassed water in the tensiometer shafts and the water in the soil to connect. The measured matric potential (also called tension) is transduced by the water down to the pressure transducer's location in the sensor unit.

To ensure the pressure is transduced precisely, the water must be air-free. Follow the steps described in the next sections to degas water in the tensiometer shafts and the sensor unit.

The boiling delay can be reached and extend the measuring range by degassing the water. See more in [Section 2.6.4](#) and [Section 2.6.5](#).

There are two possible ways to degas the water. Using the Refill Unit ([Section 2.5.2](#)), the process is automated, fast, and reliable. Using syringes ([Section 2.5.3](#)) takes more time and personal effort to reach an optimal result.

NOTE: Do not touch the ceramic of the tensiometer shafts with bare fingers. Grease or soap reduce the hydrophilic characteristics of the ceramic.

2.5.2 USING THE REFILL UNIT

The METER Refill Unit can be used for optimal automatic water degassing in the tensiometer shafts and the HYPROP sensor unit. Please note the cautions below before beginning the set-up and degassing process explained in this section

CAUTION

The following safety information must be strictly followed:

- Read all applicable safety instructions thoroughly and always follow the recommendations.
- Do not use any device if the electrical wire is damaged.
- Always release the vacuum before opening any connection or removing a device.

METER group is not liable for equipment if it is not manufactured by the METER group.

After following [Procedure Steps](#) the Refill Unit should match with the layout shown in [Figure 13](#).

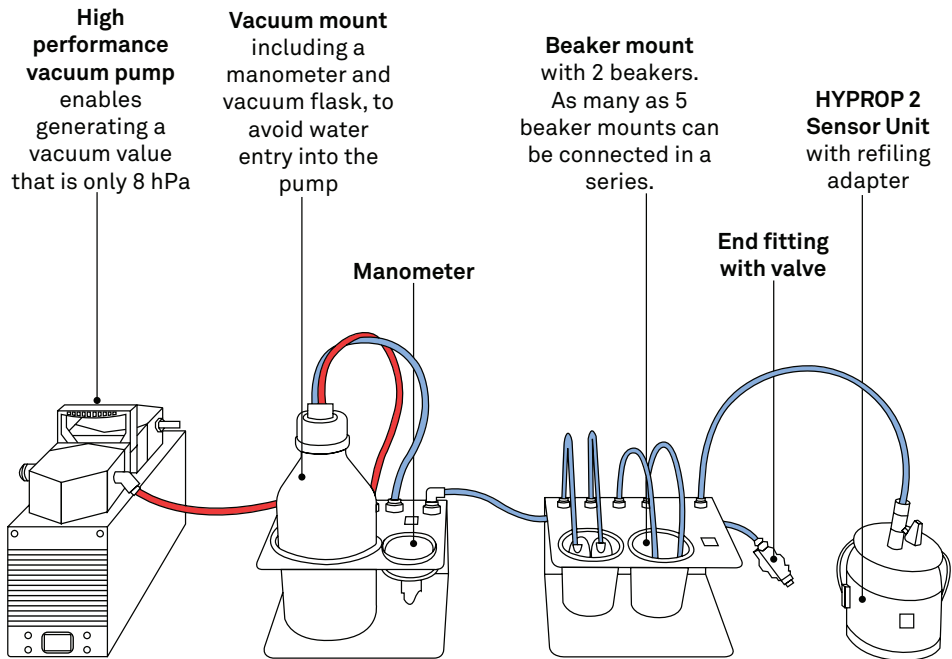

Figure 13 METER Refill Unit

PROCEDURE STEPS

1. Connect vacuum mount and beaker mount.
2. Connect vacuum mount and vacuum pump.
3. Connect the end fitting with valve to the beaker mount.
4. Fill the beakers with distilled water and place them in the beaker mount.
5. Screw in the tensiometer shafts and place them in the beaker glasses.
6. Place the refill adapter on the HYPROP sensor unit.
7. Fill the refill adapter with the 23 mL of distilled water using a syringe.
8. Connect the HYPROP sensor unit.
9. Close the valve.
10. Connect a timer to the vacuum pump and set the timer for 5 min on and 55 min off.
The timer is not included as the electrical requirements vary from country to country.
11. Start the vacuum pump.
12. Check if the vacuum reaches 0.8 bars using the manometer.

OPERATION

- When the pump turns off, check if the applied vacuum stays constant. If not, check the tube connections for leaks.
- Keep it running for approximately 24 h.
If the components were continuously stored in water before, the 24 h time period can be reduced to overnight.
- Turn off the vacuum pump.
- Open the valve slowly to ventilate the system.
- The devices can now be removed.

NOTE: More than one beaker mount and HYPROP sensor unit can be connected to the refill unit. METER recommends connecting five beaker mounts and five HYPROPs maximum.

2.5.3 USING SYRINGES

- Place the ceramic tips of the tensiometer shafts in deionized water overnight (Figure 14). Be sure that no water can enter the shaft from the open end. Otherwise air will be locked in the pores of the ceramic tip.

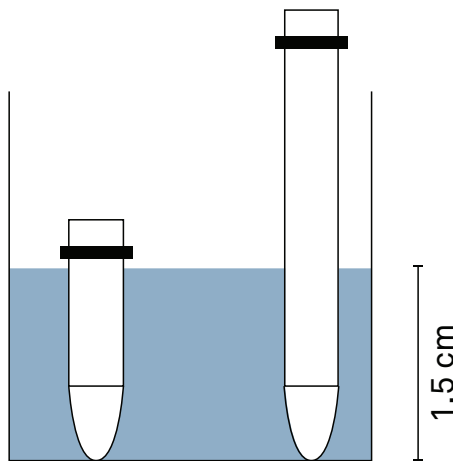

Figure 14 Saturate ceramic tips

- Fill the reservoir syringe with 10 mL deionized water.
- Turn the syringe upside down and remove residual air Figure 15.

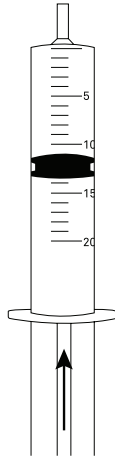

Figure 15 Fill reservoir syringe

4. Cover the reservoir syringe tightly with a finger.
5. Pull the plunger out and hold it [Figure 16](#).
The vacuum in the syringe degasses the water. This can be seen by air bubbles appearing.

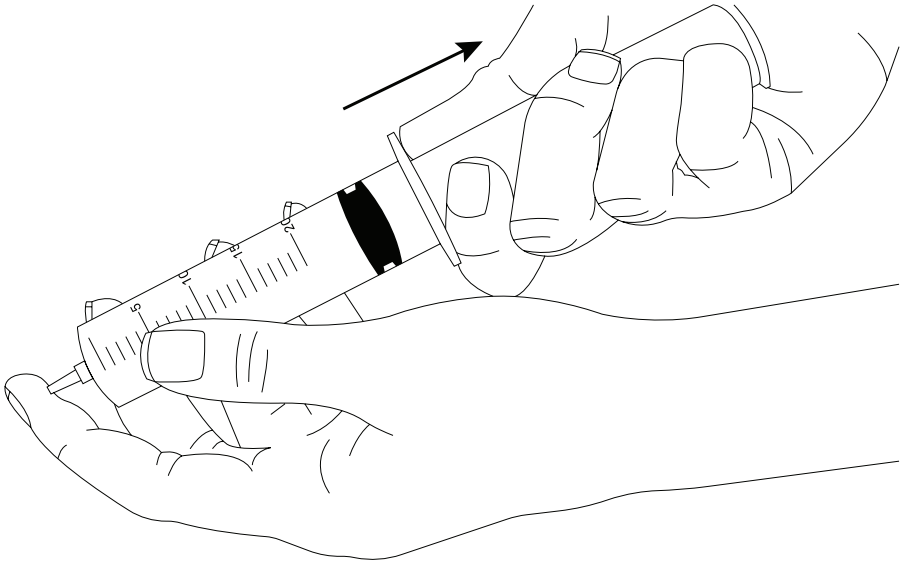

Figure 16 Degassing water in reservoir syringe

6. Shake and turn the reservoir syringe to collect the air bubbles appearing at the inner surface of the syringe [Figure 17](#).
7. Turn the syringe upside down and remove the residual air.

OPERATION

- Repeat this procedure until no more air bubbles appear.
- Push the tube piece on the tip of the syringe (Figure 17).

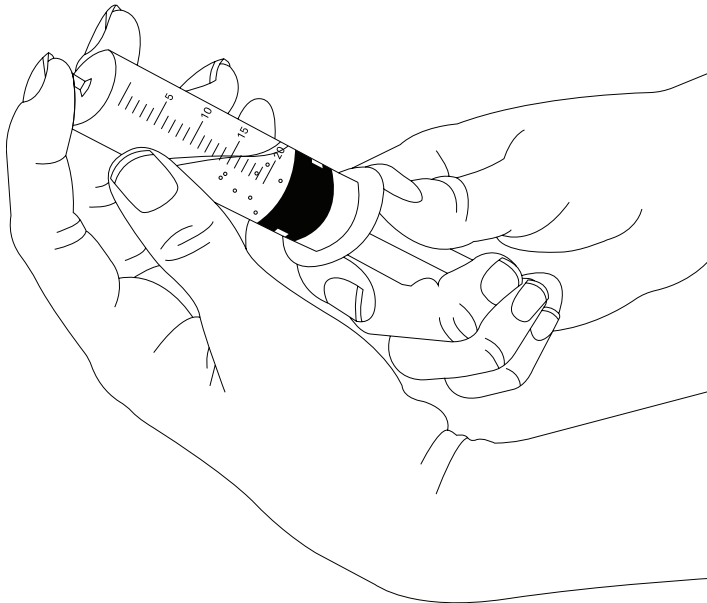

Figure 17 Collecting air bubbles

- Push the plunger of the syringe until a meniscus builds up on the tube piece (Figure 18).

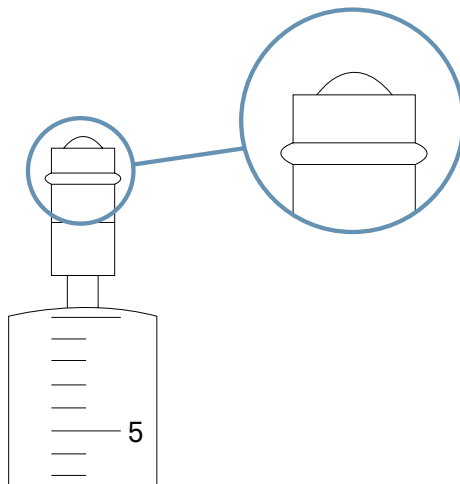

Figure 18 Build a meniscus

- Push the ceramic of the first tensiometer shaft into the tube piece (Figure 19).

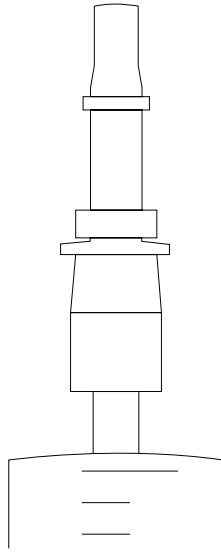

Figure 19 Insert tensiometer shaft

12. Fill the vacuum syringe with 5 mL deionized water. Turn the syringe upside down and remove residual air (Figure 20).

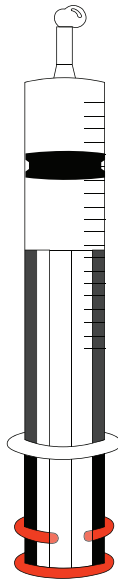

Figure 20 Fill the vacuum syringe

13. Degas the water in the vacuum syringe (similar to the process using the reservoir syringe).

OPERATION

14. Push the tube piece over the tip of the syringe.
15. Push the plunger of the syringe until a meniscus builds up on the tube piece.
16. Connect the two syringes and the tensiometer shaft (Figure 21).
The two O-rings seal the tubes against the tensiometer shaft.

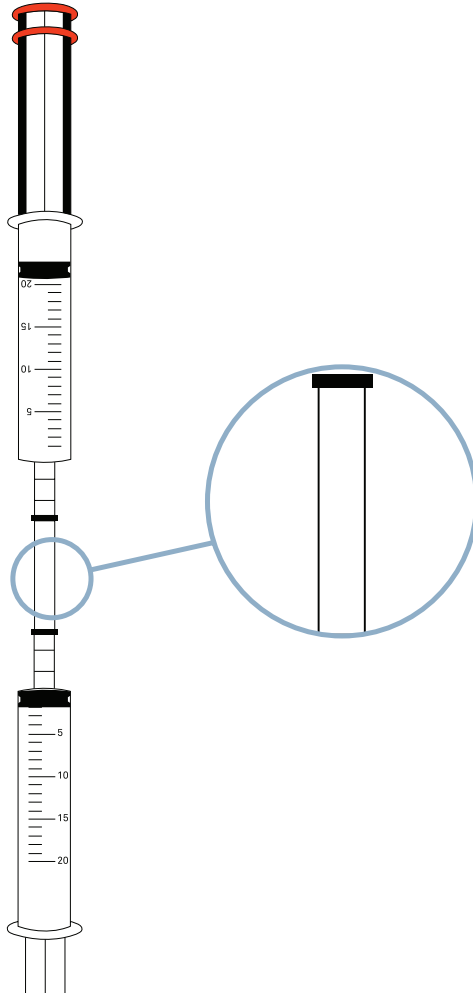

Figure 21 Connect the syringes

17. Pull on the plunger of the vacuum syringe until the plunger stoppers snap (Figure 22).
The vacuum in the syringe degasses the water in the tensiometer shaft.

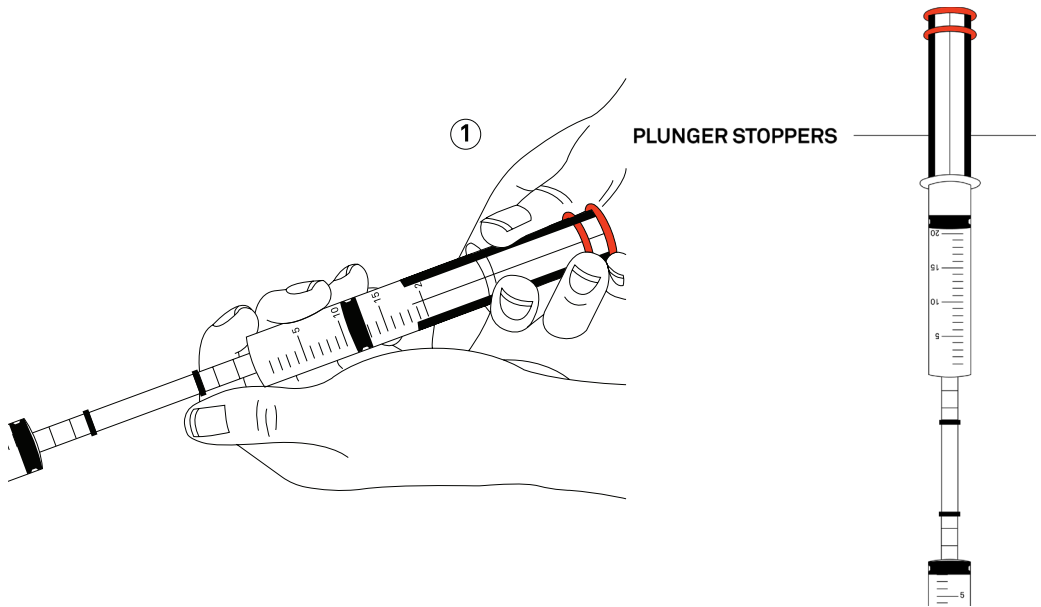

Figure 22 Let the plunger stoppers snap

18. Hold the plunger and syringe, press in the plunger stoppers and let the plunger slowly move forward (Figure 23).

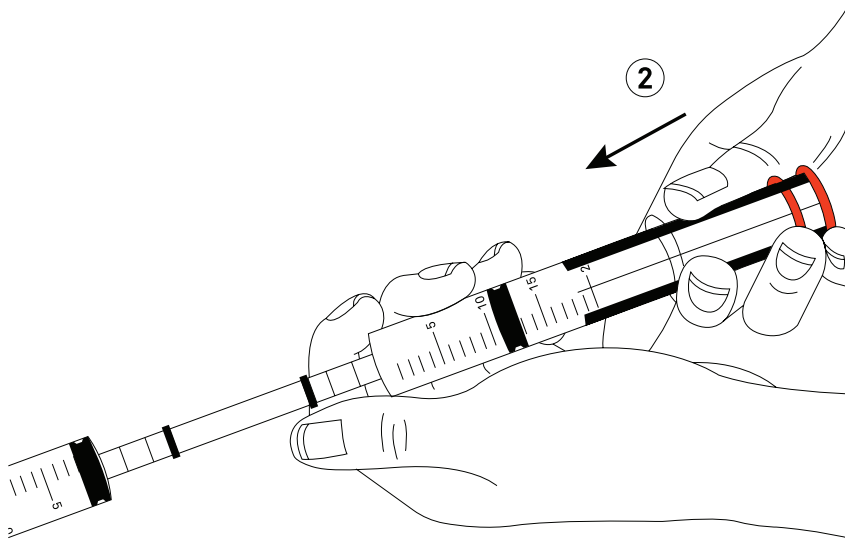

Figure 23 Release the plunger

19. Remove the syringe then turn it upside down and remove residual air (Figure 24).

OPERATION

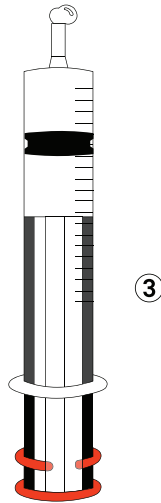

Figure 24 Remove air

20. Again, push the vacuum syringe bubble free onto the tensiometer shaft.
Degas the water in the second tensiometer shaft, performing the same steps until no more air bubbles are shown.
21. Fill the holes of the HYPROP sensor unit with deionized water using the droplet syringe (Figure 25).
Be sure there are no bubbles as you fill the HYPROP sensor tensiometer shaft holes.

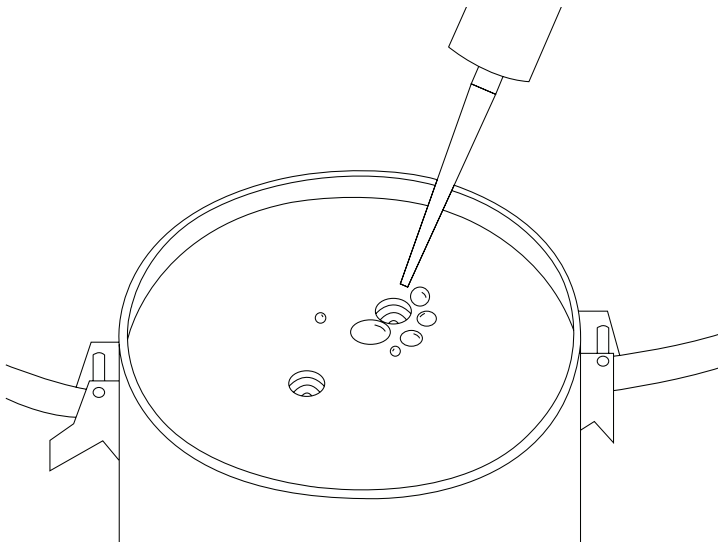

Figure 25 Fill HYPROP holes

⚠ CAUTION

Do not stick the syringe tip into the holes of the sensor unit. You may damage the pressure sensor.

22. Place the refilling adapter on top of the sensor unit and attach it.
23. Fill the refilling adapter bubble free with 23 mL deionized water using the droplet syringe (Figure 27).

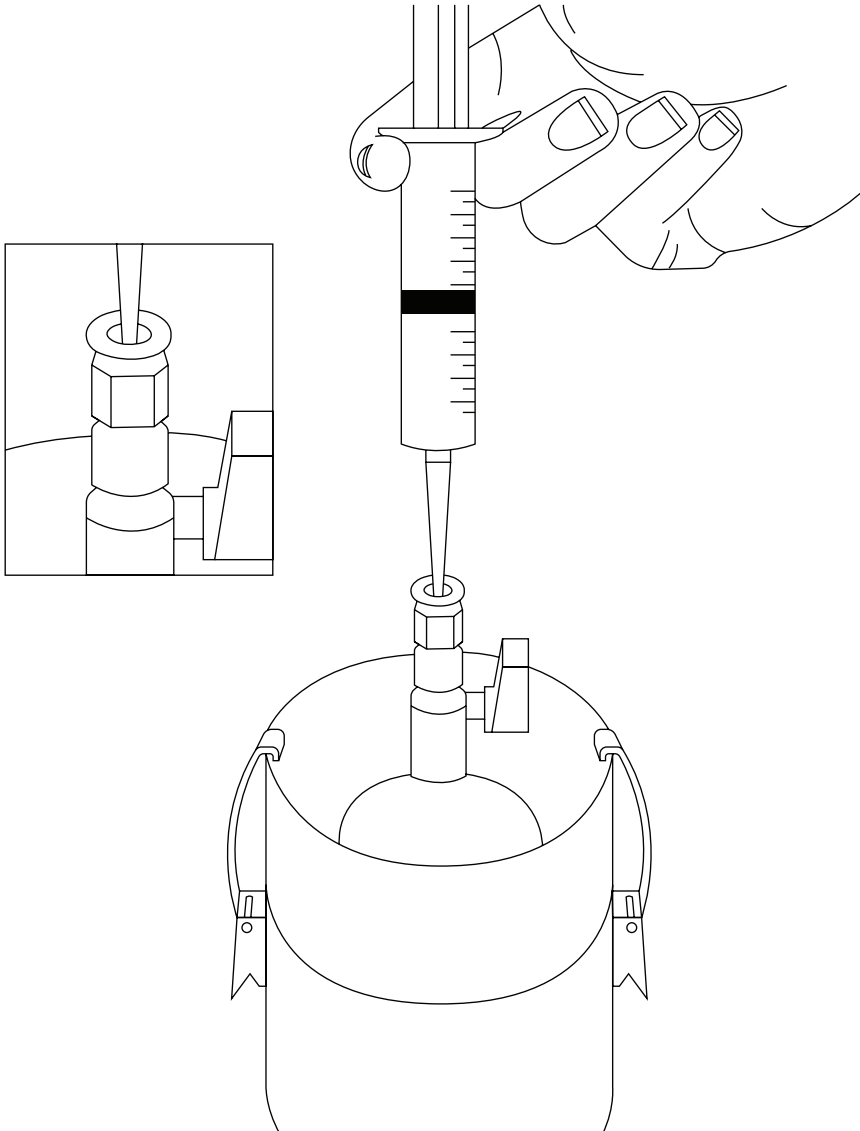

Figure 27 Fill the refilling adapter

OPERATION

24. Fill the vacuum syringe with 15 to 20 ml deionized water.
25. Degas the water in the syringe as explained above.
26. Push the blue tube piece onto the vacuum syringe and fill the tube (Figure 28).

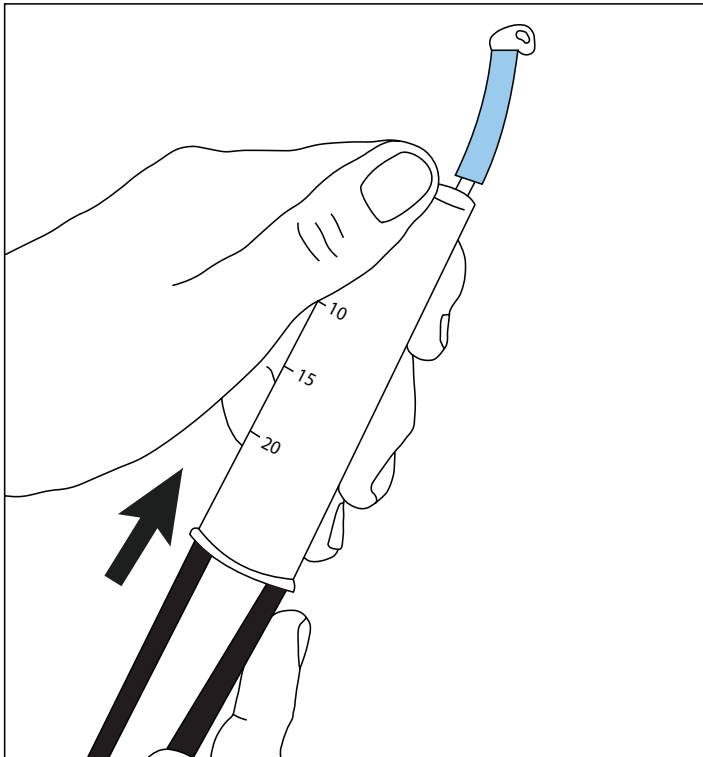

Figure 28 Fill the vacuum syringe

27. Connect the blue tube onto the fitting of the refilling attachment.
28. Pull out the plunger of the vacuum syringe until the plunger stoppers snap (Figure 29).
The vacuum in the syringe removes the air from the water in the sensor unit and the refilling adapter. Air bubbles will appear if the air-removal process is working.
29. Let the air bubbles rise up into the tube by cautiously knocking and shifting the sensor unit (Figure 30).

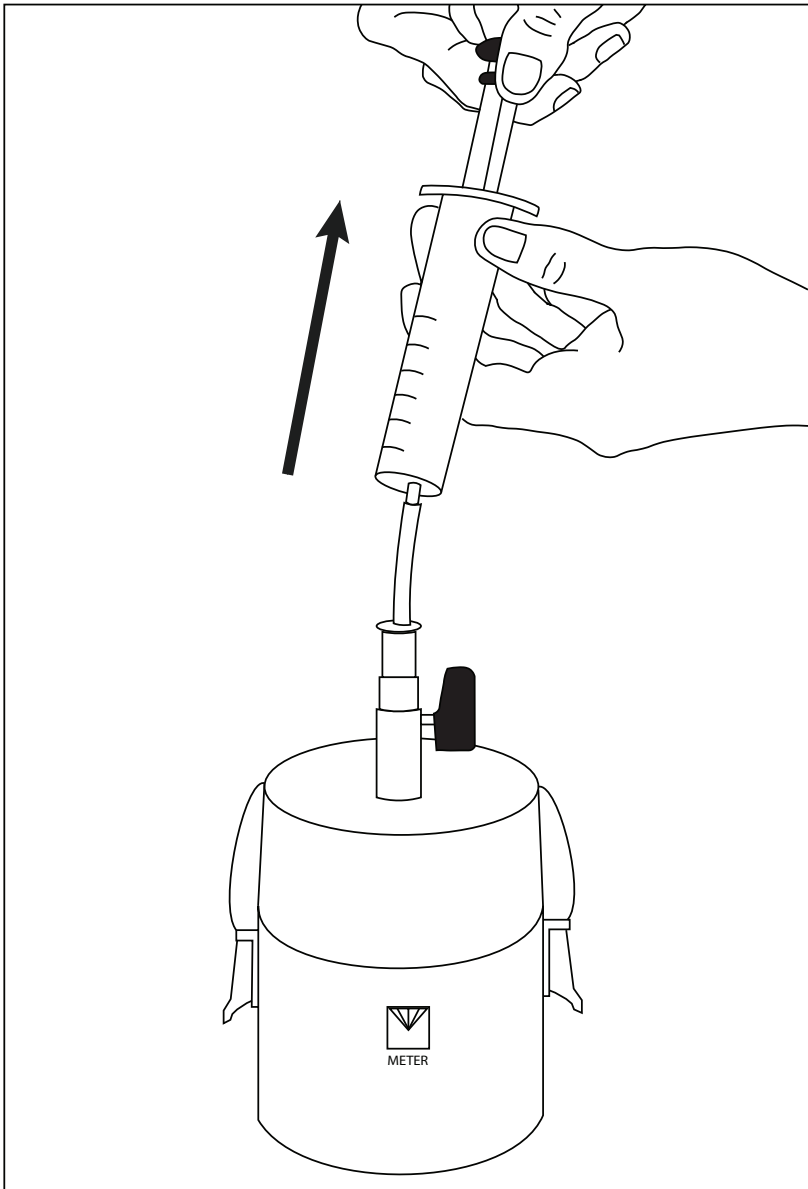

Figure 29 Degas the water in the sensor unit

⚠ CAUTION

Be extremely cautious. Do not let the plunger of the syringe shoot down as the pressure shock will damage the pressure sensor.

OPERATION

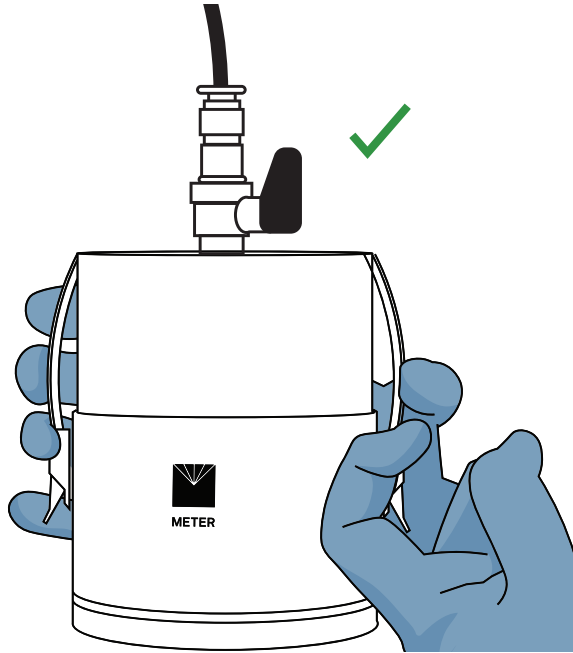

Figure 30 Remove air bubbles

PRECAUTION

Never bump the sensor unit on a hard surface. The impact will cause pressure shocks that damage the pressure sensors (Figure 31).

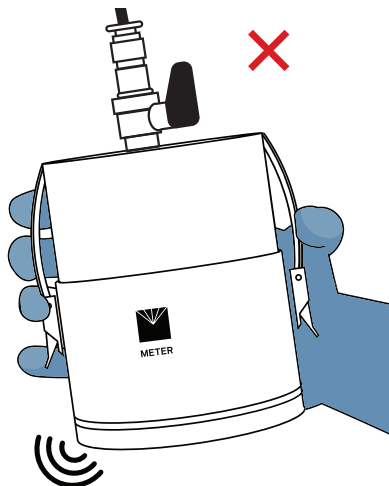

Figure 31 Caution: do not bump on hard surface

30. To relieve the pressure, hold the plunger and the syringe. Next press in the plunger stoppers and let the plunger slowly move forward (Figure 32).

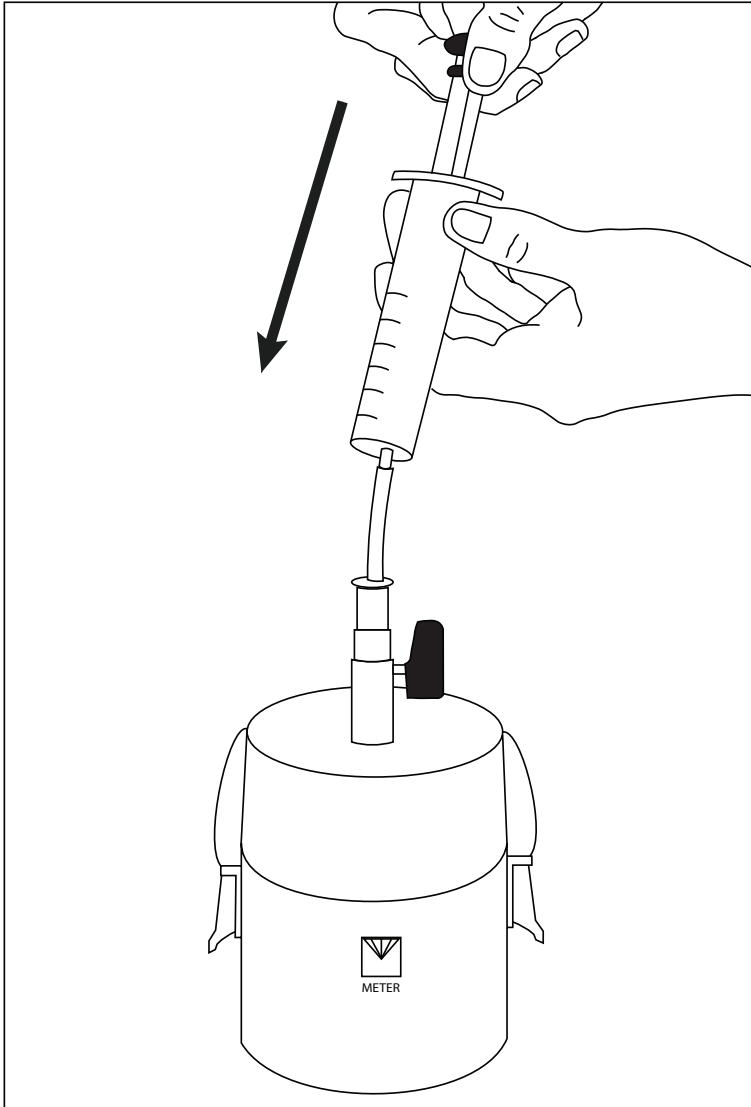

Figure 32 Release the plunger

⚠ CAUTION

Be extremely cautious. Do not let the plunger of the syringe shoot down as the pressure shock will damage the pressure sensor.

OPERATION

31. Remove the syringe from the tube, turn it upside down, and remove residual air (Figure 33).

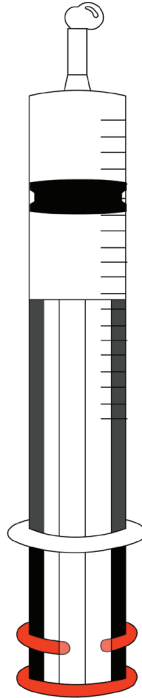

Figure 33 Remove air

32. Repeat [step 29](#) through [step 31](#) until no air bubbles are visible.
33. Push the vacuum syringe filled with degassed water into the tube on the refilling adapter.
34. Pull the plunger until the plunger stoppers snap in.

The pressure shown on the screen of the Refilling Wizard in LABROS SoilView Software must reach a vacuum value equal to the atmospheric air pressure minus 20 hPa (2 kPa). If this value can be reached the sensor unit is ready for measurement after about 3 h.

If the vacuum value does not reach a pressure equal to the atmospheric air pressure minus 20 hPa (2 kPa), the reasons might be:

- A dead volume in the syringe
- Air in the tube
- A leakage in the system (e.g., between the sensor unit and the refilling adapter)

After the problem is fixed, the system must be degassed again.

2.5.4 OFFSET RECALIBRATION

Over time the zero point of the HYPROP sensors may drift. By using the function **Offset Recalibration** before mounting the tensiometer shafts, the software automatically verifies if the offset values for both pressure transducers are within the range set by METER development (± 0.5 hPa). The software provides recommendations when offset recalibration is needed. Contact METER [Customer Support](#) if there is any problem setting the zero point.

It is recommended to do this test routinely before mounting the tensiometer shafts. LABROS SoilView software and an USB adapter are needed to complete the zero point sensor test. Follow the steps described below.

1. Complete the refilling procedure following one of the procedures described in [Section 2.5.2](#) and [Section 2.5.3](#).
2. Open LABROS SoilView software.
3. Take one HYPROP sensor unit from the refill unit and connect it to the computer via HYPROP USB adapter (it is not possible to complete this step by connecting the HYPROP sensor unit to a balance).

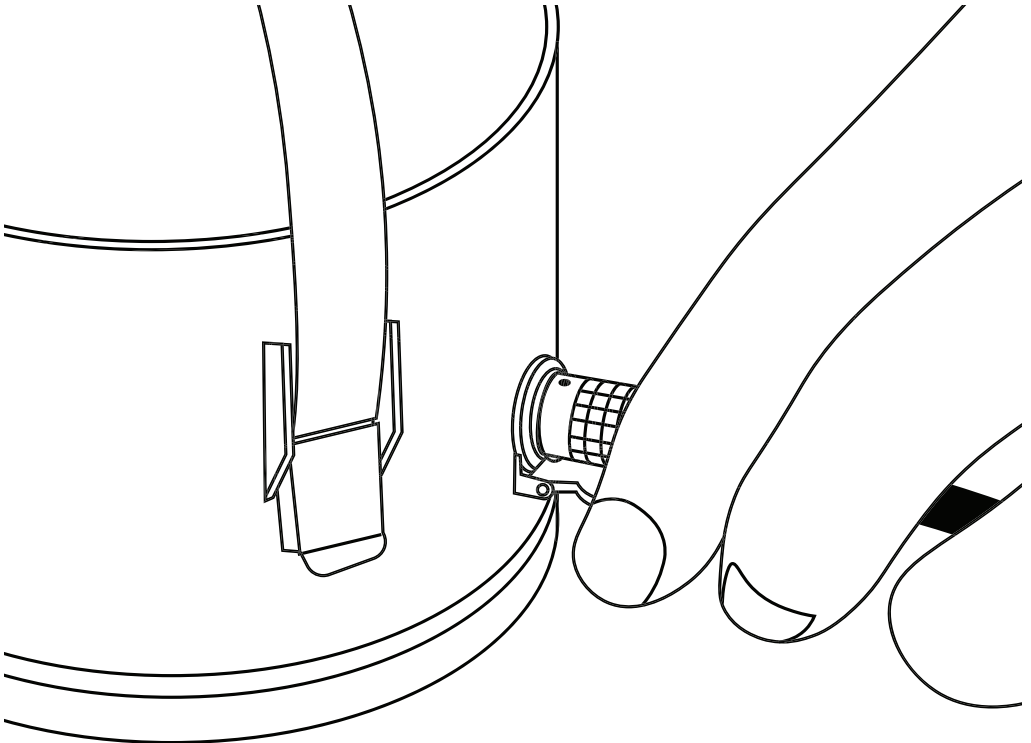

Figure 34 HYPROP connected to tensioLink adapter

OPERATION

4. Select Show Devices (Figure 35).

The device should be listed on the left side of the software screen.

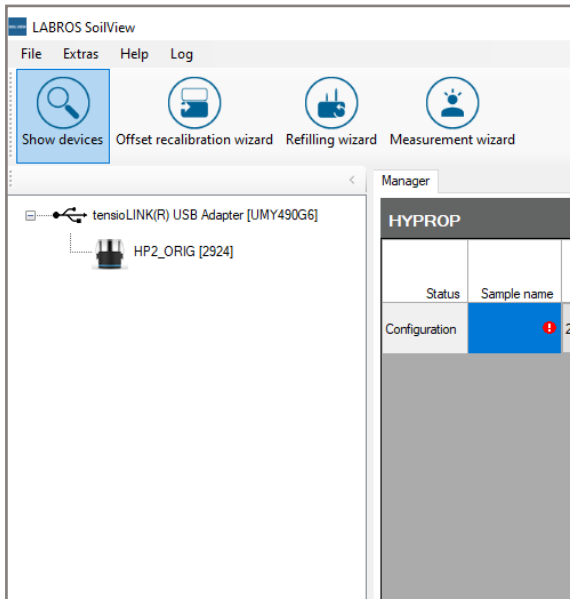

Figure 35 Show devices

5. Carefully remove the refilling adapter so that the water remains on the HYPROP sensor unit.
6. Select Offset Recalibration Wizard and choose the device you want to process by using the drop down menu to select HYPROP Device (Figure 36).

The software window displays the current deviations to the zero point as well as the current temperature. It also gives a short overview of the steps that need to be done (Figure 37).

HYPROP 2

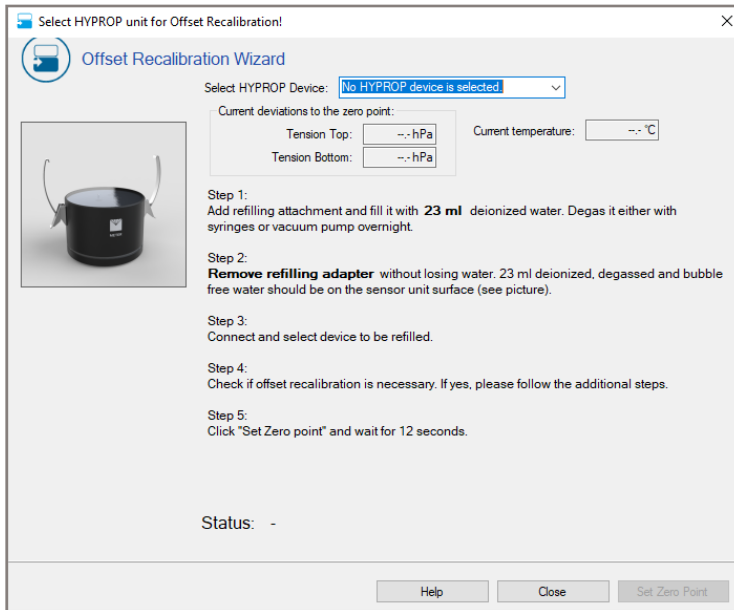

Figure 36 Offset Recalibration

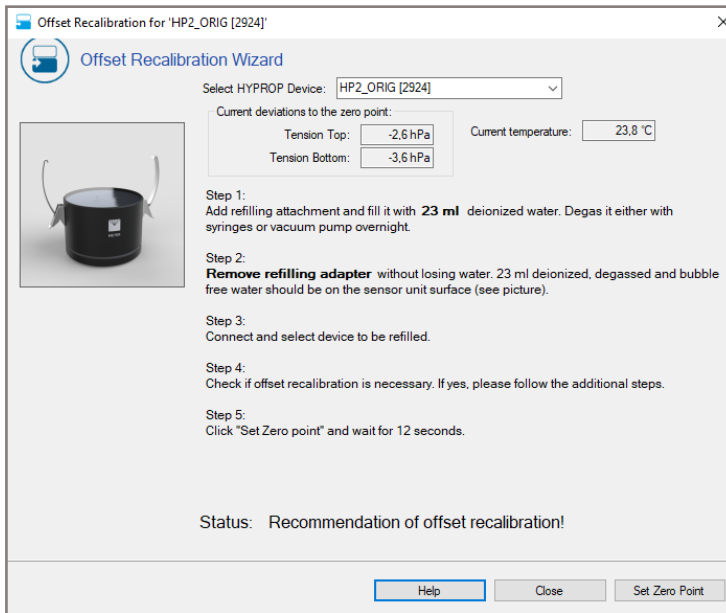

Figure 37 Offset Recalibration - connected device

7. Take the appropriate action depending on the status as shown in [Table 3](#).

Table 3 Recalibration Status and Action

Status	Action
Recommendation of offset recalibration!	Select Set Zero Point . Do not disturb the process by moving or bumping the HYPROP.
No offset recalibration necessary!	Select Close and proceed with Section 2.5.5
Value is out of range! Please be sure to follow all steps described in this Wizard as well as the manual.	If all steps are processed correctly and the value is still out of range, please contact METER support for a device checkup.

NOTE: Be careful not to hit the sensor unit or the table during the recalibration. This may affect the result.

8. Close the window.

2.5.5 INSTALLING TENSIO METER SHAFTS INTO SENSOR UNIT

Equipment needed for implementing tensiometer shafts in the sensor unit include:

- LABROS SoilView software
- USB adapter
- Syringe with degassed water
- Gloves or silicone tube
- Paper towel
- Silicone disk
- Beaker

Follow the steps below to complete tensiometer shaft implementation:

1. Complete the refilling procedure following one of the methods described in [Section 2.5.2](#) or [Section 2.5.3](#).
2. Complete recalibration as described in previous [Section 2.5.4](#)
3. Keep the HYPROP sensor unit connected via HYPROP USB adapter so that it is shown on the left side of the software screen.
4. Open the window Refilling Wizard by selecting the respective icon and choose the desired device to process by using the dropdown menu ([Figure 38](#)).
5. Select HYPROP device.

The software window displays the current pressure on both pressure transducers. After a successful offset recalibration and before screwing in the tensiometer shafts the values should display around 0 hPa for the short shaft and around 3 hPa for the long shaft. In addition, an acoustic signal can be activated or deactivated to support the control of the process.

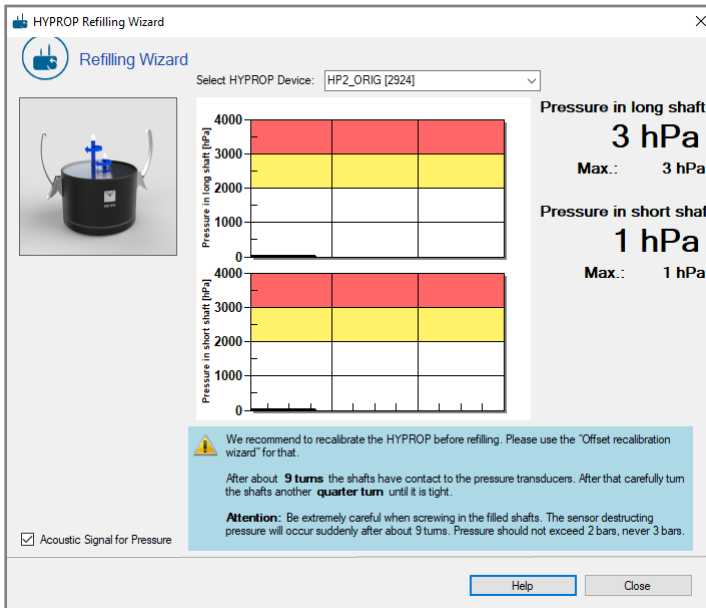

Figure 38 Refilling - connected device

6. Prepare a syringe filled with distilled, degassed water.
7. Wear gloves and unscrew the tensiometer shafts one at a time from the refilling unit.

IMPORTANT: Be careful not to tilt the tensiometer shaft or to lose any water. Never touch the ceramic tips with bare fingers as grease or soap reduces the hydrophilic characteristics of it. Use a silicone tube on the ceramic tip to protect it.

If needed, use the syringe filled with degassed water to build a water lens on top of the tensiometer shaft (Figure 39).

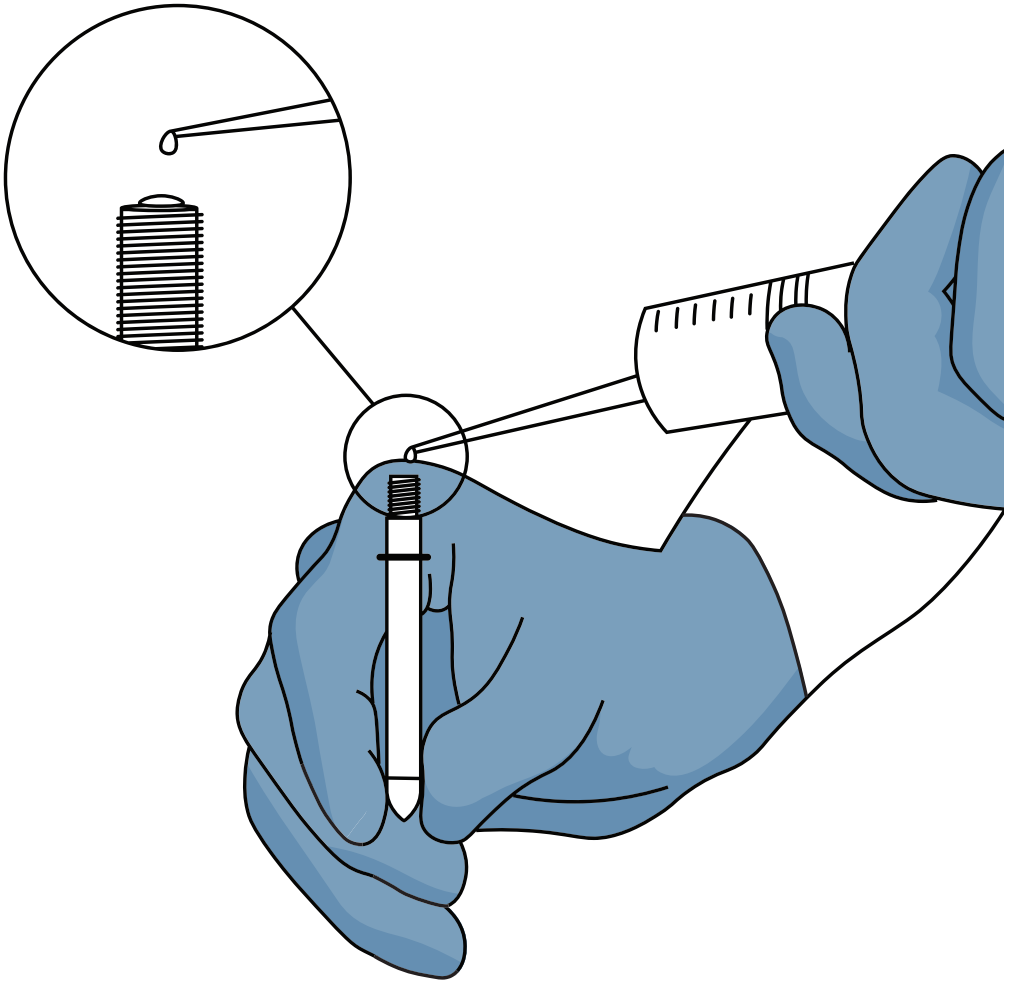

Figure 39 Water lens

8. Screw in the tensiometer shafts one at a time, in the matching marked hole (i.e., the longer shaft screws into the hole marked long and the short shaft into the hole marked short) (Figure 40).

Be careful not to enclose any air while screwing in the shafts.

IMPORTANT: Always keep the ceramic tip wet during this process. Keep it wet using a water-filled silicone tube on the ceramic tip or by moistening it periodically with the syringe.

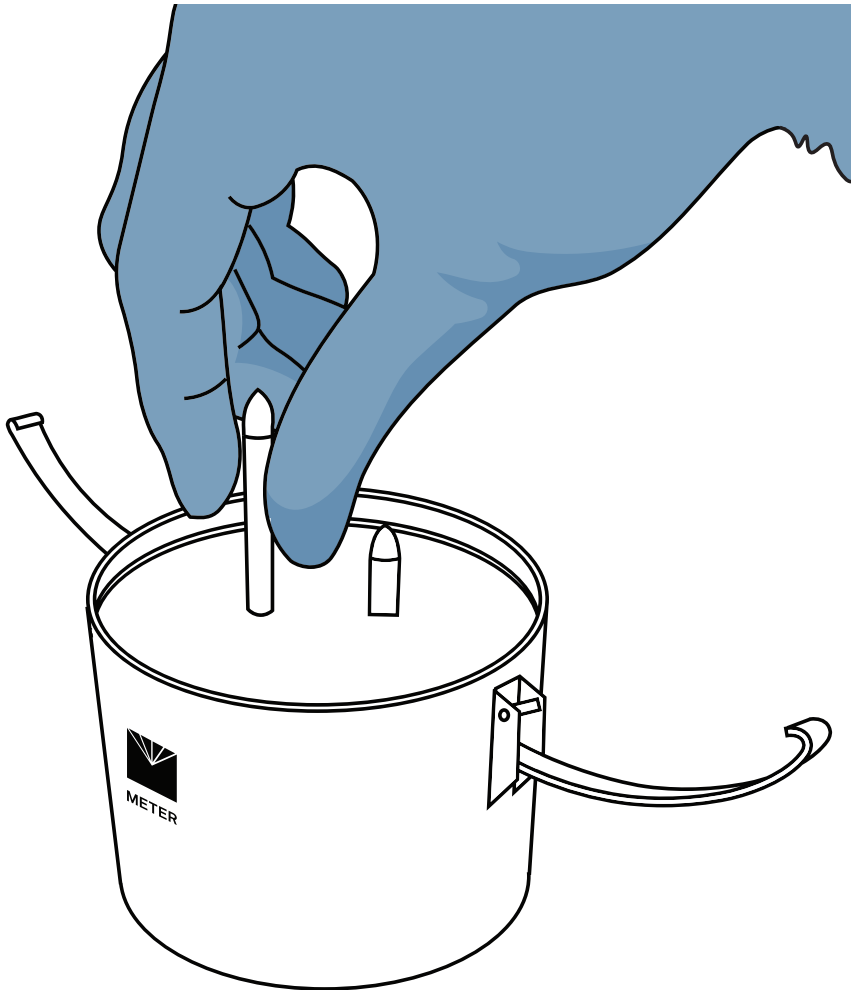

Figure 40 Screwing in tensiometer shafts

9. Screw the tensiometer shaft carefully until the O-ring in the sensor unit starts sealing and the pressure increases rapidly.

Monitor this by observing the pressure values visualized in the Refilling Wizard.

10. Screw in with small turns until the tensiometer shaft is tight.

Pay close attention to the pressure values, ensuring that they remain under 3000 hPa (Figure 41) to prevent damage to the pressure transducers.

NOTE: If the Refilling Wizard is used while a measurement is running, a timer is set to two minutes as the measurement has to be interrupted. The device will be disconnected automatically after two minutes. The timer can be reset by selecting the respective icon.

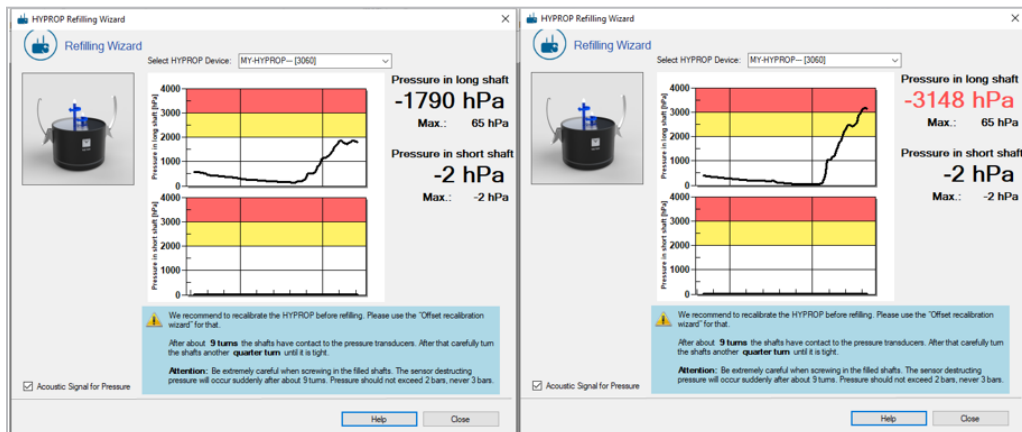

Figure 41 Pressure range

IMPORTANT: Read [step 11](#) and [step 12](#) before completing these steps as the process of function check goes by very fast.

11. Moisten the ceramic tip and let the pressure go down to 0 hPa.
12. Next ensure the unit is correctly prepared to take a measurement by performing the following test:
 - a. Keeping a syringe filled with degassed water on hand, dry the ceramic tip with a paper towel.
After that, the value should quickly change (approx. 15 s) up to at least 900 hPa (atmospheric air pressure). If it goes up to more than 1000 hPa, the so-called boiling delay can be reached. Reaching the boiling delay means an extension of the measurement range.
 - b. Moisten the ceramic tip right after the value reaches 900 hPa or 1000 hPa to prevent air entering the tensiometer shaft.

It is important to prevent air entering the shaft. Air in the tensiometer shaft means the degassing process must be repeated.

If the value does not reach 900 hPa or the value rises quite slowly, unscrew the tensiometer shaft again, put it back to the refill unit and try another one.

Potential reasons for not reading 900 hPa:

- i. Air is in the tensiometer shaft.
- ii. Tensiometer shaft is not screwed in strong enough to be tight with the O-ring.
- iii. Ceramic tip is clogged (e.g., by oils from fingers).
- iv. Red O-ring in the HYPROP sensor unit is worn out.

See [Section 4.2.1](#) for changing the O-ring.

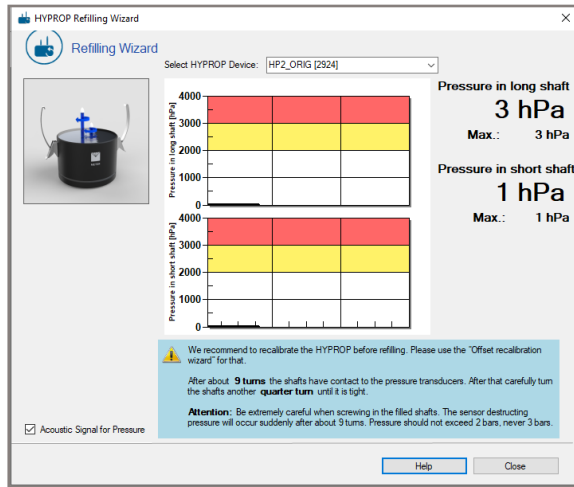

Figure 42 Testing refilling

13. Repeat all steps for the second tensiometer shaft.
Always remember to keep both ceramic tips moistened.
14. When both tensiometer shafts are screwed in successfully, disconnect the HYPROP sensor unit from the USB adapter and close the Refilling Wizard.
15. Remove the water from the sensor unit and put the black O-rings of the tensiometer shafts for dirt protection into the notches.

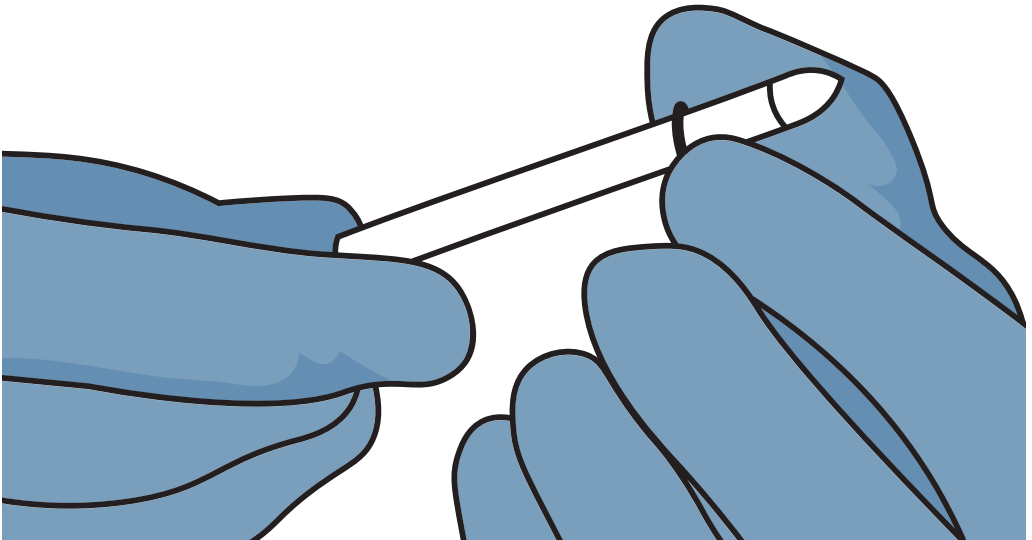

Figure 43 Put black O-rings on tensiometer shafts

OPERATION

- Place the silicone disk on the sensor unit and remove any air between the surface and the disk (Figure 44).

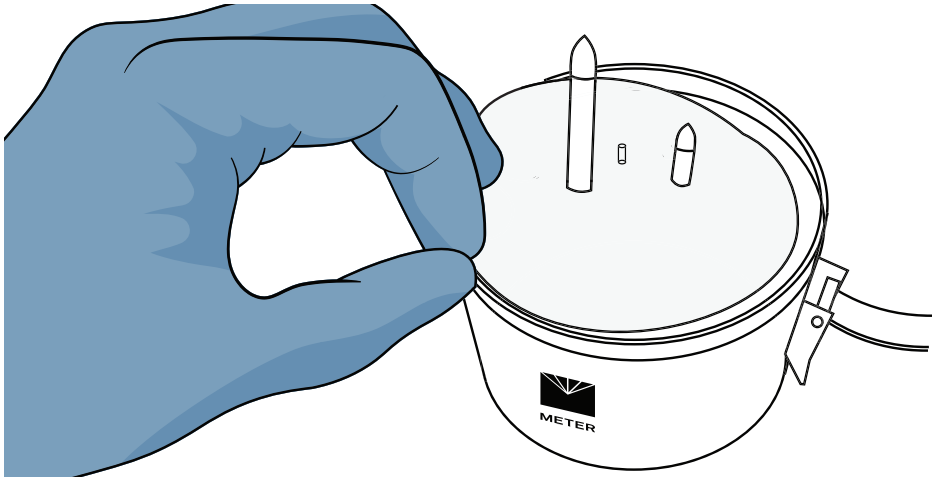

Figure 44 Silicone disk

- Turn the assembled HYPROP upside-down and place it in a beaker filled with distilled water. Be sure that both ceramic tips are dipped in the water (Figure 45).

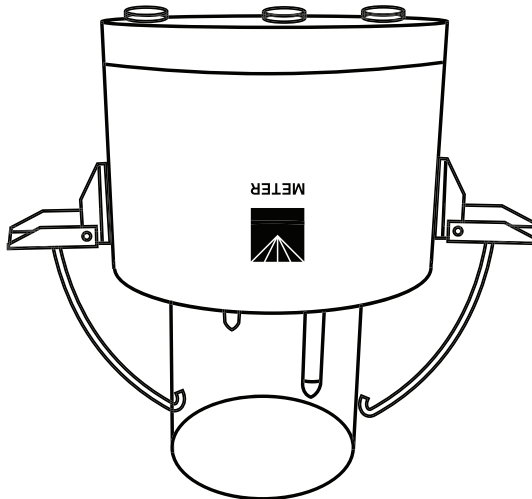

Figure 45 Storing refilled HYPROP

- The device is now ready for the soil sample to be mounted.

2.5.6 HYPROP SENSOR UNIT AND SOIL SAMPLE

To assemble the HYPROP sensor unit and soil sample you will need the following equipment:

- Hand auger for tensiometer shafts
- Drilling adapter
- Syringe with water
- Paper towel

Complete the steps below to assemble the HYPROP sensor unit and soil sample:

1. Perform the soil sample preparation as described in [Section 2.4](#)
2. Perform the preparation of the device as described in [Section 2.5](#)
3. Place the drilling adapter on the cutting-edge of the saturated soil sample in the tray. Be sure that the adapter is not placed askew.
4. Use the hand auger to drill both tensiometer shaft holes in the soil sample ([Figure 46](#)).

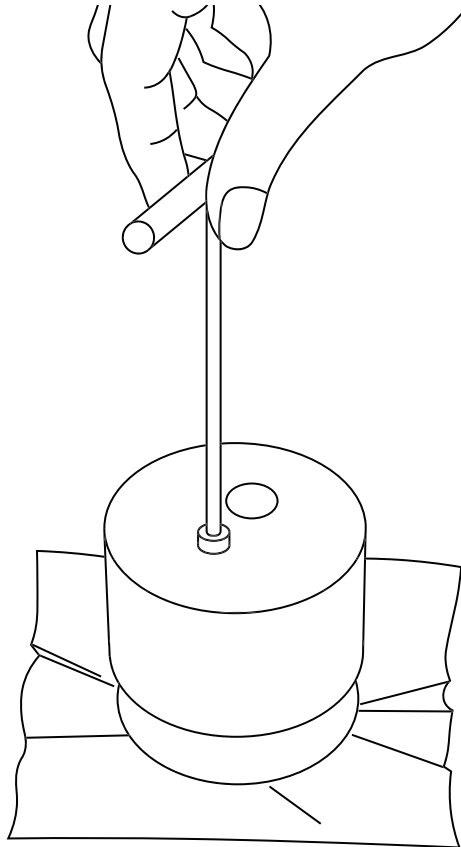

Figure 46 Drilling the holes

OPERATION

5. Drill the long hole in three steps and the small hole in two steps to avoid compressing the soil.

The material of the holes does not have to be weighed or stored as this volume is automatically mentioned as a subtracted volume in the evaluation.

NOTE: Before removing the drilling adapter, remember which one is the hole for the long shaft and which hole is for the short shaft.

6. Take off the drilling adapter and fill the holes with water out of the syringe to make sure no air will be pressed into the soil sample while assembling.

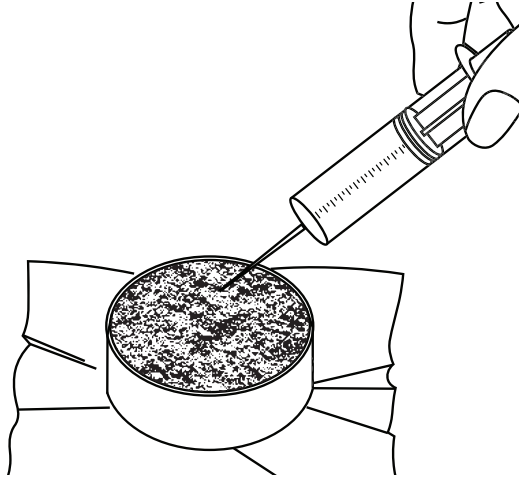

Figure 47 Filling the holes

7. Place the HYPROP sensor unit carefully upside down onto the cutting-edge of the soil sampling ring.
8. Place the tensiometer shafts cautiously in the correct hole while be careful not to compress the soil.

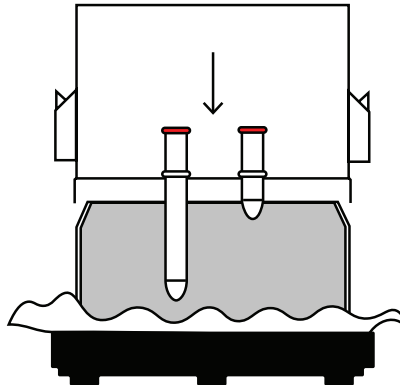

Figure 48 Assembling the HYPROP unit

9. Turn the whole setup around and place it out of the tray.
For more stability the clips can be fixed at the saturation plate.
10. Remove the saturation plate, fix the soil sampling ring with the clips, and put a lid on top of the sample with the nonwoven cloth to avoid evaporation before the measurement starts.
11. Clean and dry the soil sampling ring and the clips with a paper towel or a brush. Otherwise water and dirt will be weighed too.



Figure 49 Fix and clean the soil sampling ring

12. The soil sample is now ready to be measured.

2.5.7 LABROS BALANCE

The LABROS Balance should be placed on a horizontal, vibration-free and solid surface where the temperature remains fairly stable (away from air conditioner and heater vents, windows, etc.). Ideally this place is not used for other laboratory work during HYPROP measurement.

Adjust the balance by turning the balance adjusters until the air bubble rests in the center of the red circle in the level. Connect the balance to the power supply and to the computer via USB and turn it on.

2.5.7.1 BALANCE CALIBRATION

For a precise measurement the balance must be calibrated according to the local conditions. It should be calibrated when it has been set up initially, after a change of position or after a change of temperature. Calibration is also required after long periods without use, or if a balance begins to produce inaccurate values. The balance is equipped with an internal calibration weight. During the calibration process be aware that wind or vibration may result in an unsuccessful calibration.

OPERATION

1. Be sure nothing is placed on the balance and that there are no magnet cables in use (see [Section 2.6.1](#) for connecting magnet cables).
2. Tare the balance.
3. Press the **Function** button until **S.A. CAL** appears.
4. Press the buttons **Function** and **Zero/Tare** at the same time and release them at the same time.
5. Wait until **CAL . ON** appears on the display.
6. Turn the blue calibration knob on the right side of the balance to **CAL**.
The internal weight will be activated. The adjustment runs automatically.
7. Turn the calibration knob back to **WEIGH** when the display reads **CAL . OFF**.

Calibration is finished when the display reads **END**.

The calibration can be checked by taring the balance and using a 1 kg weight to verify the shown value. This should be in range of ± 0.05 g.

2.5.7.2 DEFAULT SETTINGS FOR HYPROP MEASUREMENT

Locate settings by pressing the **Function** button until **func** is read on the display. [Table 4](#) shows the recommended settings for HYPROP measurement.

Table 4 Recommended Balance Settings

Item	Display	Setting Adjustment
Bar graph	1. B.G. 1	1=on
Limit function	2. SEL 0	0=off
Auto-zero	3. A.0.1	1=on
Response speed	5. rE. 3	3=medium speed
Stability parameters	6. S.D. 2	2=medium sensitivity
Interface	7. I.F. 1	1=six-digit numeric format

Select an item by pressing the **Function** button. Change an item by using the **Zero/Tare** button and terminate the function selection by pressing the **Set** button.

2.5.7.3 TROUBLESHOOTING THE BALANCE

See [Table 5](#) for troubleshooting the balance.

Table 5 Troubleshooting the Balance

Error	Possible reasons
0-Err	A weight heavier than the capacity was used.
1-Err	The reference weight is less than 50% of the capacity.
2-Err	Calibration produced an error of 1.0% or more.
3-Err	Adjustment was performed with something loaded on the measurement pan.
4-Err	Mechanism was damaged.

2.6 HYPROP MEASUREMENT MODES

The HYPROP measures the soil water retention curve and the unsaturated hydraulic conductivity function of undisturbed soil samples in the range between water saturation and close to the permanent wilting point. The simplified evaporation method is based on Wind (1966) and Schindler's (1980) model.

NOTE: Before starting the HYPROP measurement, deactivate the computer standby mode and automatic updates to avoid interrupting tests.

The different measurement modes as well as the procedure of a HYPROP measurement is described in the following sections.

2.6.1 MEASURING WITH MULTI-BALANCE MODE

Multi-balance mode (Figure 50) describes the setup consisting of:

- One balance for each sensor unit
- Balance connected to the computer via USB hub
- USB adapter used for connecting separate devices for preparation steps

NOTE: The USB hub is not included with any HYPROP kit. METER recommends a powered USB hub.

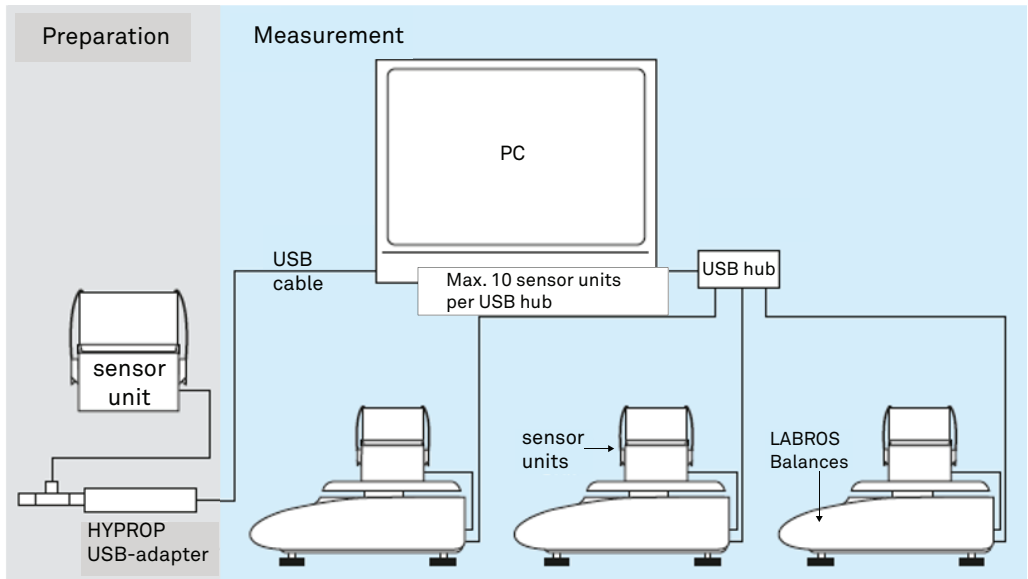

Figure 50 Multi-balance mode

2.6.1.1 STARTING A MEASUREMENT

After preparing the sample and the devices properly, use the following steps to perform the HYPROP measurement using the multi-balance mode.

1. Connect the magnet cables to the balances as shown in [Figure 51](#).

NOTE: The cable must lie freely without touching anything.

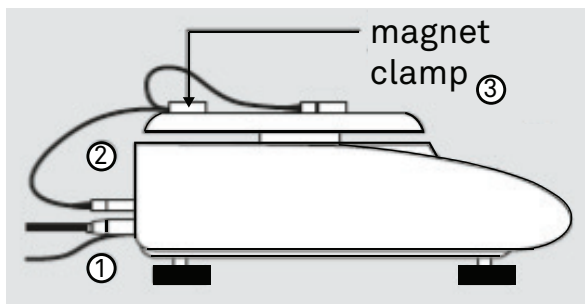

Figure 51 Magnet cable

2. Tare the balance including the magnet cable.
3. Place the sensor unit in the middle of the circle on the balance and connect it to the magnet cable.
4. Repeat [step 1](#) through [step 3](#) for every balance and sensor unit used.

HYPROP 2

NOTE: This method is tested for a maximum of 20 balances and HYPROP sensor units (maximum 10 HYPROP sensor units per USB hub).

LABROS SoilView software automatically displays all connected balances and sensor units on the left side of the software screen (Figure 52). If not, check if the balances are turned on and all connected HYPROP sensor units have individual device IDs (Section 3.2.2).

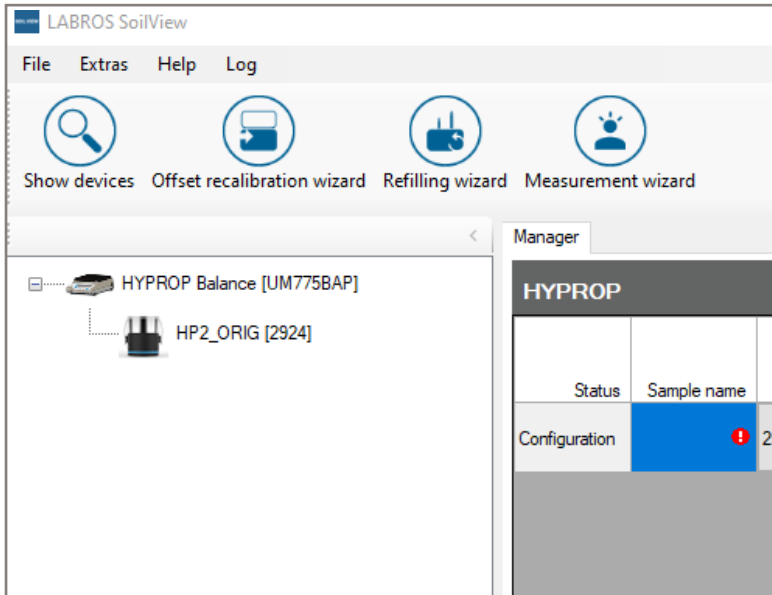

Figure 52 Connected devices

The measurement profile is automatically set to one balance per HYPROP (Figure 53).

Device	Measurement Profile	Mode Measurement Interval Display Unit	
HP2_ORIG [2924]	Example HYPROP Profile one balance per HYPROP	one balance per HYPROP 00:10:00	...

Figure 53 Measurement profile

5. Configure the measurements either by using the Measurement Wizard or the manager.

2.6.1.2 MEASUREMENT WIZARD OPTION

1. Open the Wizard by clicking on the Measurement Wizard icon (Figure 54).

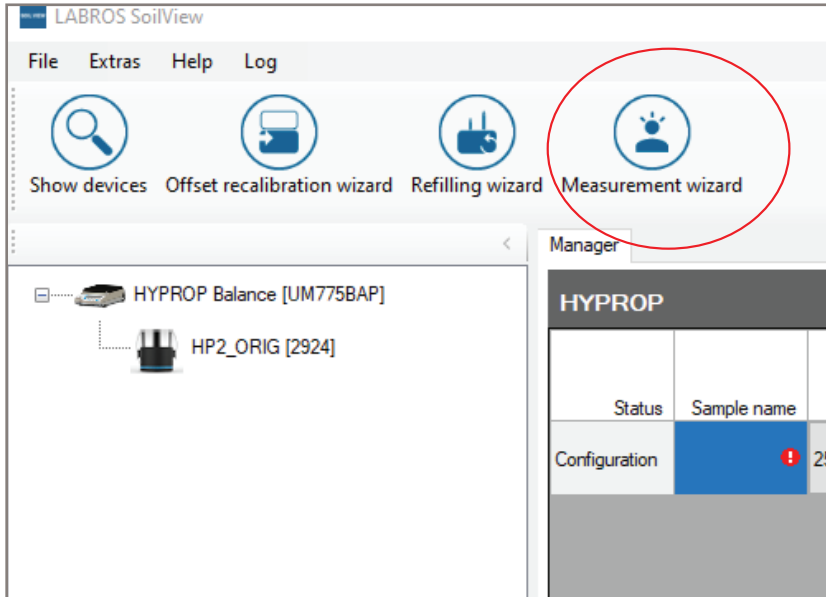

Figure 54 Measurement Wizard icon

2. Select the HYPROP sensor unit that contains the soil sample to be measured.
3. Enter the sample name as well as the storage location.
The balance will be automatically detected. Sampling ring type and empty soil sampling ring weight can be selected and entered either here or later in the LABROS SoilView-Analysis evaluation software.
4. Select **Apply** to start the measurement (Figure 55).

Figure 55 Select Apply in Start Measurement Wizard

5. Remove the lid and the nonwoven cloth and clean.
6. Dry the soil sampling ring carefully with a paper towel.
7. Repeat [step 1](#) through [step 5](#) in [Section 2.6.1.1](#) for all HYPROP sensor units to be measured.
8. Leave the measurement systems undisturbed in an area free of vents, windows, or foot traffic that could bump or shake the sensor units.

Weight and tension values will be recorded automatically in a defined frequency (default: 10 min) until the measurement is stopped. See [Section 2.6.7](#) for information on how and when to stop a measurement.

2.6.1.3 START MANAGER OPTION

1. Enter sample name and storage location in the line showing the HYPROP and soil sample to be measured ([Figure 56](#)).

The balance is automatically detected. Sample ring type and empty soil sampling ring weight can be selected and entered here or after measurement is completed using the LABROS SoilView-Analysis software.

OPERATION

HYPROP											Start All
Status	Sample name	Type of sampling	Filename	Device	Measurement Profile	Mode Measurement Interval Display Unit	Balance	Empty soil sample ring weight (g)	Next measurement Start measurement Duration	Last readings Tension top Tension bottom Weight	Start
Ready to start	Test	250 ml	C:\Users\Alina\Desktop\Test\Test.khob...	HP2 ORIG (2924)	Example HYPROP Profile one balance per HYPROP	one balance per HYPROP 00:10:00	HYPROP Balance (UM7758AP)				Start

Figure 56 Start manager

2. Select **Start** to start the measurement.
3. Remove the lid and the nonwoven cloth and clean.
4. Dry the soil sampling ring carefully with a paper towel.
5. Repeat [step 1](#) through [step 5](#) in [Section 2.6.1.1](#) for all HYPROP sensor units to be measured.

Using the manager there is also the possibility to configure all measurements and start them all at the same time, using the button **Start All** ([Figure 57](#)).

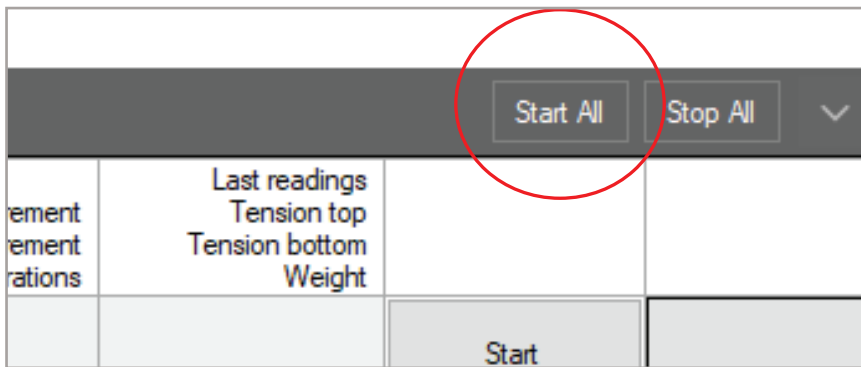

Figure 57 Start All

6. Leave the measurement systems undisturbed in an area free of vents, windows, or foot traffic that could bump or shake the sensor units.

Weight and tension values will be recorded automatically in a defined frequency (default: 10 min) until the measurement is stopped. See [Section 2.6.7](#) for information on how and when to stop a measurement.

2.6.2 MEASURING WITH SINGLE-BALANCE MODE

Single-balance mode describes the setup consisting of one balance for multiple sensor units. A maximum of twenty sensor units can be used with one balance using single-balance mode.

2.6.2.1 STARTING A MEASUREMENT

After preparing the sample and the devices properly, use the following steps to perform the HYPROP measurement using the single-balance mode.

1. Connect one tensioLink T-piece and HYPROP connection cable per HYPROP sensor unit to the HYPROP USB adapter.

NOTE: This method is tested for a maximum of 20 HYPROP sensor units.

2. Connect all HYPROP sensor units to be measured to the HYPROP connection cables and click on Show devices in the left upper corner of the software screen.

The connected devices as well as the balance are shown on the left side. If not, check if the balance is turned on and all connected HYPROP sensor units have individual device IDs (Section 3.2.2).

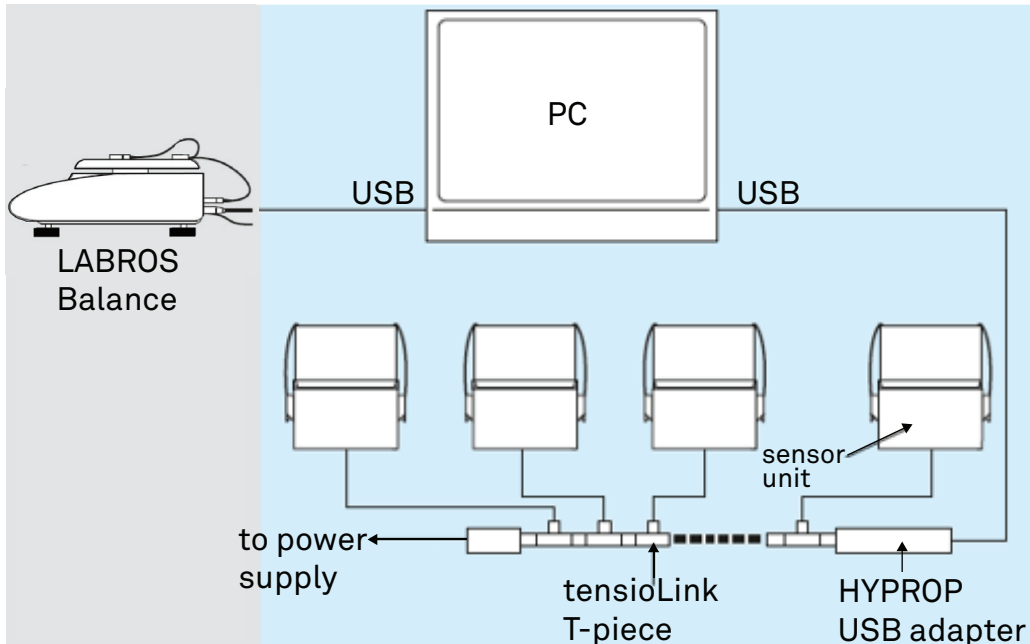

Figure 58 Single-balance mode

NOTE: The measurement profile is automatically set to one balance for more HYPROP.

Device	Measurement Profile	Mode Measurement Interval Display Unit	
HP2_ORIG [2924]	Example HYPROP Profile one balance for more HYPROP	one balance for more HYPROP 00:10:00	...

Figure 59 Measurement single-balance mode

3. Configure the measurements either by using the Measurement Wizard or the manager.

2.6.2.2 USING THE MEASUREMENT WIZARD

1. Open the Measurement Wizard by clicking on the Measurement Wizard icon (Figure 60).

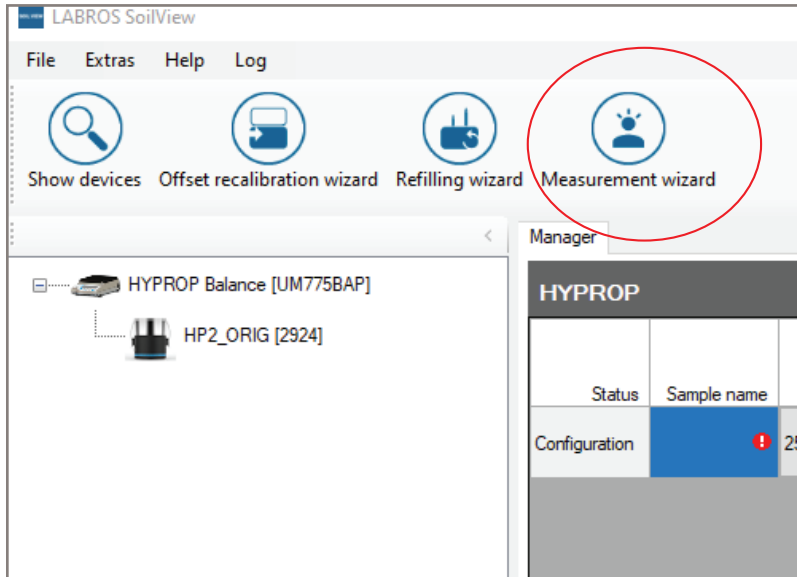

Figure 60 Measurement Wizard icon

2. Select the HYPROP sensor unit with the soil sample to be measured.
3. Enter the sample name as well as the storage location.

The balance will be automatically detected. Sample ring type and empty soil sampling ring weight can be selected and entered here or after measurement is completed using the LABROS SoilView-Analysis software.

4. Select **Apply** to start the measurement (Figure 60).

Figure 61 Select Apply in Start Measurement Wizard

5. Remove the lid and the nonwoven cloth and clean and dry the soil sampling ring carefully with a paper towel.
6. Repeat steps in [Section 2.6.2.1](#) for all HYPROP sensor units to be measured.

The Manager also has an option to first configure all measurements and then start them at the same time using the Start All button ([Figure 62](#)).

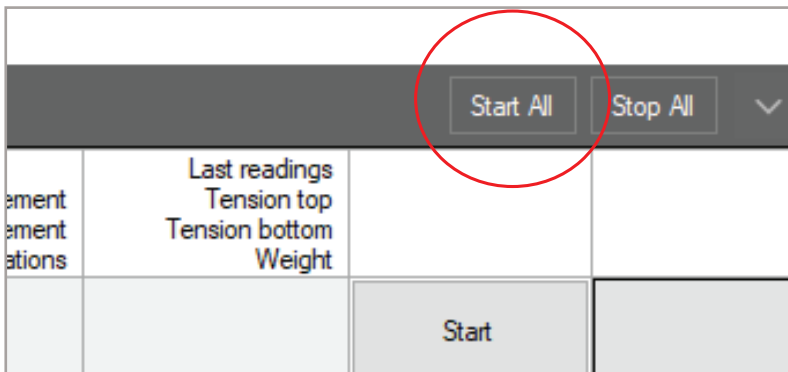

Figure 62 Start All

7. Leave the measurement system undisturbed.

Tension values will be recorded automatically in a defined frequency (default: 10 min) until the measurement is stopped. Weight values must be taken manually. See [Section 2.6.3](#) for weighing the sample. See [Section 2.6.7](#) for information on how and when to stop a measurement

2.6.2.3 USING THE MANAGER

1. Enter sample name and storage location in the line showing the HYPROP sensor unit with the soil sample to be measured.

The balance will be automatically detected. Sampling ring type and empty soil sampling ring weight can be selected and entered either here or later in the LABROS SoilView-Analysis evaluation software.

2. Select **Start** to start the measurement ([Figure 63](#)).

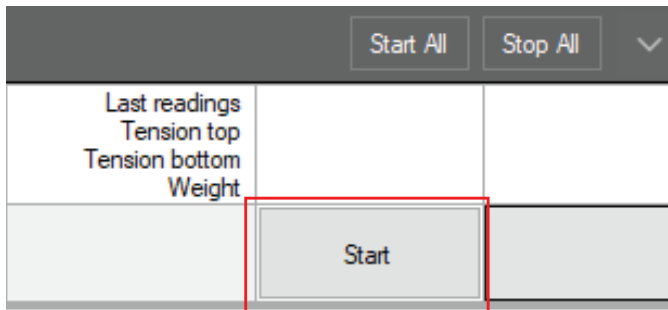

Figure 63 Start in Manager

3. Remove the lid and the nonwoven cloth and clean and dry the soil sampling ring carefully with a paper towel.
4. Repeat steps in [Section 2.6.2.1](#) for all HYPROP sensor units to be measured.

The Manager also has an option to first configure all measurements and then start them at the same time using the **Start All** button ([Figure 62](#)).

5. Leave the measurement system undisturbed.

Tension values will be recorded automatically in a defined frequency (default: 10 min) until the measurement is stopped. Weight values must be taken manually. See [Section 2.6.3](#) for weighing the sample. See [Section 2.6.7](#) for information on how and when to stop a measurement.

2.6.3 WEIGHING THE SAMPLE

The multi-balance mode records the weight of the soil sample automatically.

The single-balance mode weight reading must be taken manually. It is recommended to take a weight reading at least twice a day for every running measurement. Weight readings require the following steps:

HYPROP 2

1. Disconnect the HYPROP sensor unit to be weighed.
The software automatically identifies the sample that will be weighed.
2. A software window appears showing the steps to proceed (Figure 64).
3. When the reading is done, quickly reconnect the HYPROP sensor unit to the HYPROP USB adapter.
The software automatically assigns the weight reading to the correct measurement.
4. Repeat [step 1](#) through [step 3](#) for all running measurements at least twice a day.

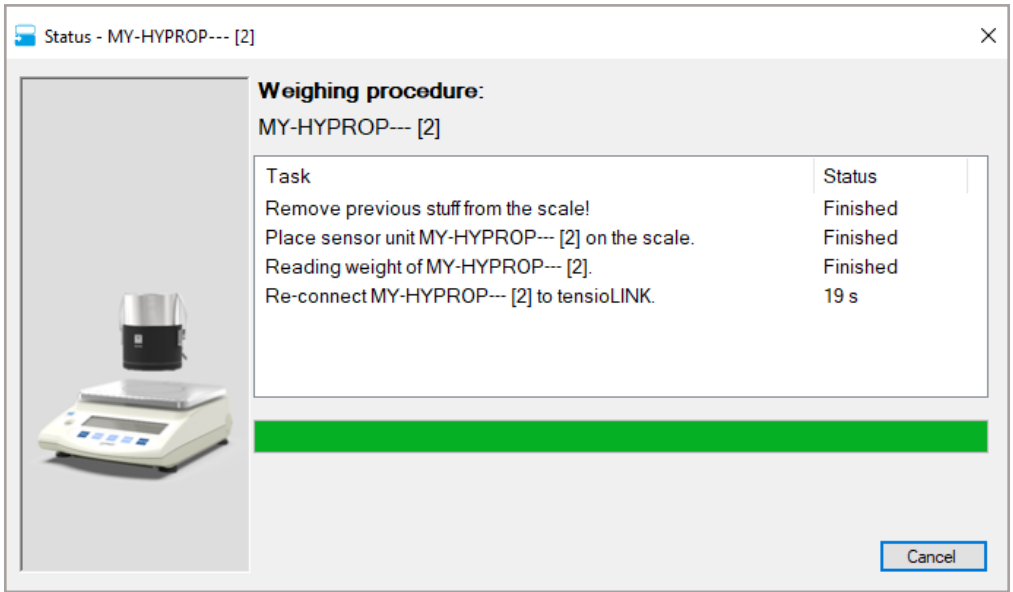

Figure 64 Weighing window

2.6.4 CONFIGURE HYPROP PROFILE

The LABROS SoilView software provides one example profile for each of the following HYPROP measurement modes:

1. One balance per HYPROP (Figure 65)
2. One balance for more HYPROPs (Figure 66)

The default settings can always be restored by selecting the **Restore** button.

Settings - HYPROP - VARIOS

General Settings **HYPROP**

HYPROP

VARIOS

Measurement Profile

Example HYPROP Profile one balance per HYPROP

Mode: one balance per HYPROP

Measurement interval [h:mm]: 00:10

Higher measurement frequency at start:

One Balance for more HYPROPs

Time for weighing procedure [mm:ss]: 00:30

It is recommended to weigh the sample twice a day

Display Tension Unit: hPa

C:\Users\Alina\AppData\Roaming\METE...\Example HYPROP Profile one balance per HYPROP.hds

Load as default HYPROP Measurement Profile

Cancel OK

Restore

Figure 65 Example HYPROP profile one balance per HYPROP

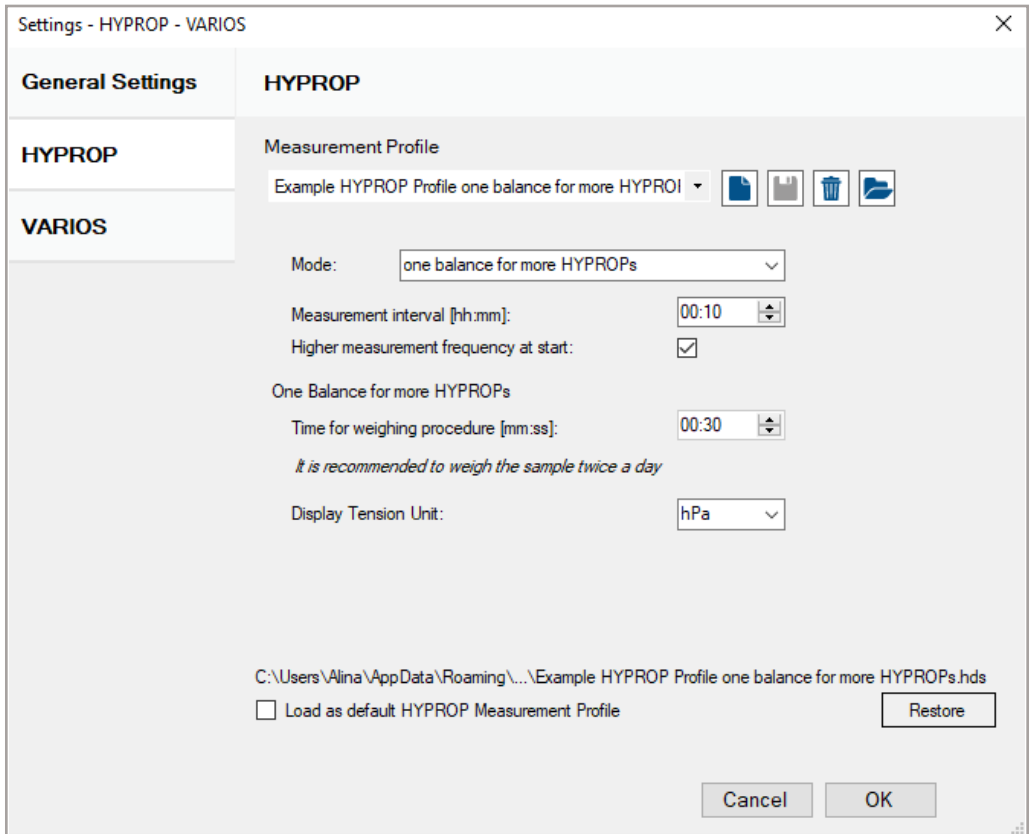

Figure 66 Example HYPROP profile one balance for multiple HYPROP's

To generate a new customized measurement profile, follow the steps below:

1. Press the **New Profile** button.
2. Enter all necessary values.
3. Press the **Save Profile** button to enter a profile name and store it.

The **Customized Measurement Profile** can now be selected for measurement configuration.

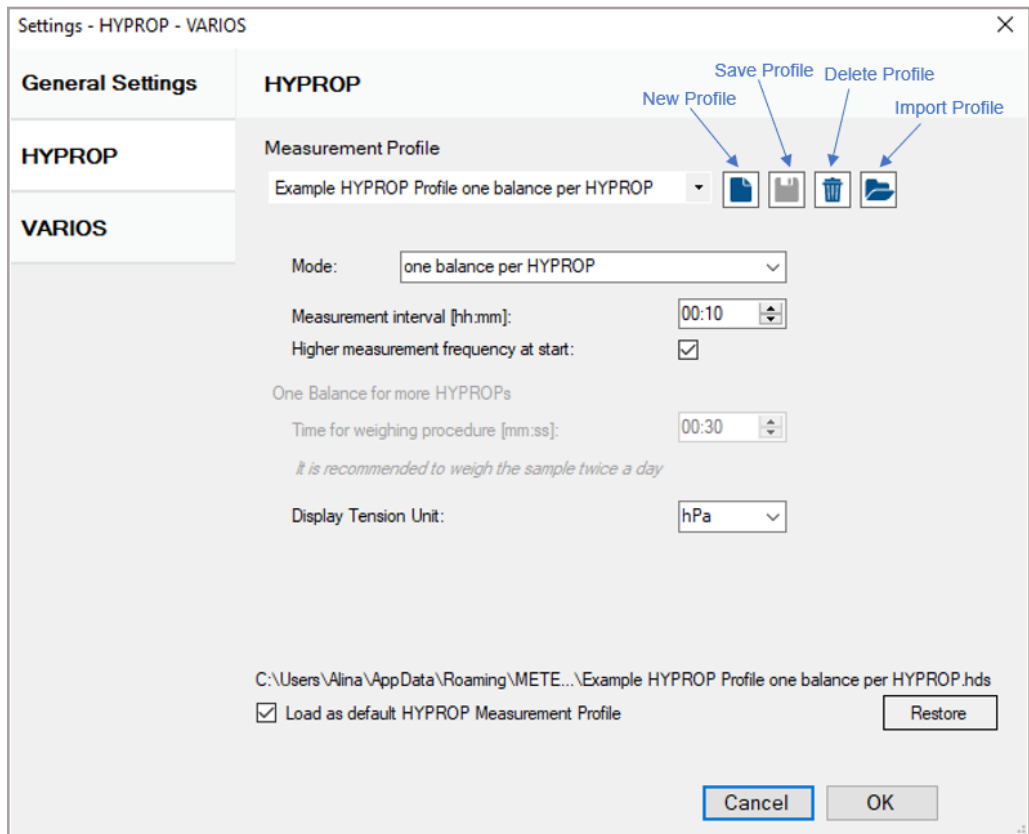

Figure 67 Generating a customized profile

Table 6 lists all parameters that can be defined for the measurement profile.

Table 6 Measurement Parameter Descriptions

Measurement Parameter	Description
One balance per HYPROP mode	Type of measurement mode
One balance for more HYPROP mode	
Measurement interval [hh:mm]	Time between tension and weight measurements.
Higher measurement frequency at start	Select the checkbox to define higher measurement frequency [00:01] during first hour of measurement.
Time for weighing procedure [mm:ss] (only available for one balance for more HYPROP mode)	Time for taring the balance, weighing the sample, disconnecting and reconnecting the device, and automatically opening the weighing window.
Display tension unit	Available tension units: sm, hPa, kPa, bar

2.6.5 OPTIMAL MEASUREMENT CURVE

Every optimal measurement can be divided into four different phases:

Phase 1: regular measurement range	Tension value curve increases without flattening until it reaches the boiling point of the water.
Phase 2: of boiling delay	Ideally, when the system is filled completely air free the tension value rises up to the boiling delay area (above the ambient air pressure). This is useful to have as it extends the measurement range but in general not necessary for a reliable evaluation.
Phase 3: cavitation	Water vapor is generated in the tensiometer shaft and the tension value drops abruptly down to the boiling point (ambient air pressure). After this the tension value decreases only slightly.
Phase 4: air entry	The tension value again drops abruptly to zero as air penetrates the ceramic. The air entry point is a material characteristic of the ceramic and amounts to about 8800 hPa (880 kPa). Note that this value may change over time and use. Read APPENDIX B to learn about how to determine the current air entry point of the ceramic. This point can also be used for the evaluation.

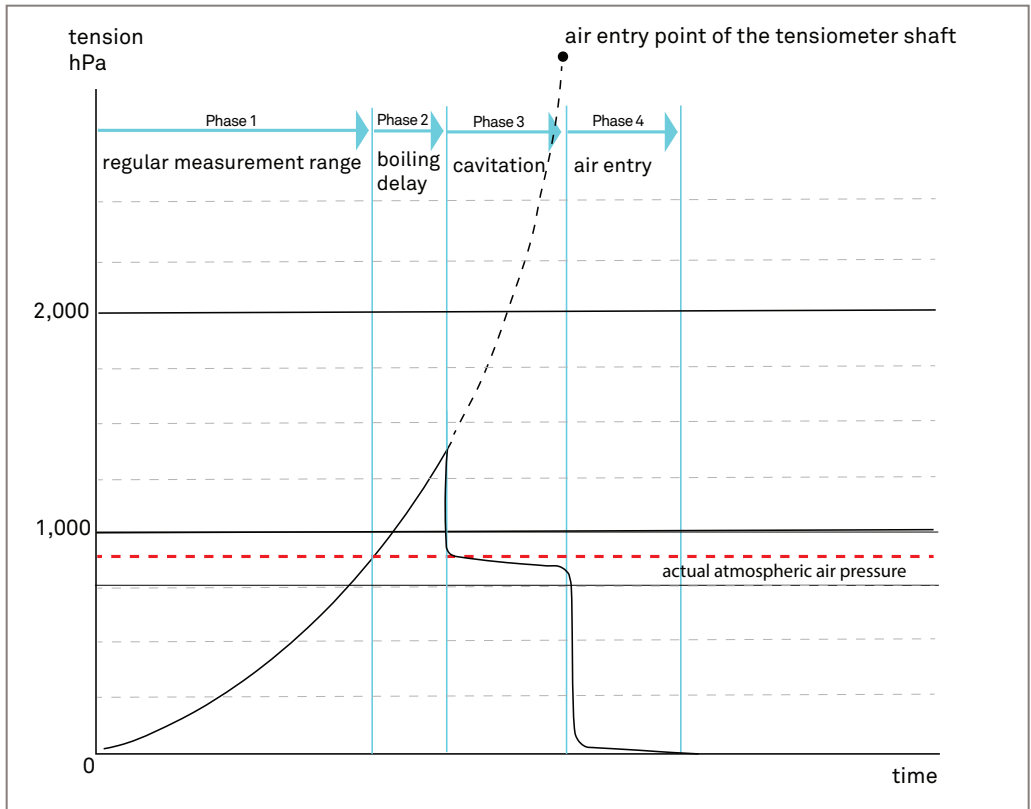

Figure 68 Measurement phases for one tensiometer shaft

Please refer to [APPENDIX C](#) for example measuring curves for various soils.

2.6.6 SUBOPTIMAL MEASUREMENT CURVE

Sometimes the optimal measuring curve up to the boiling delay cannot be achieved. There are different potential causes when the values do not reach the boiling delay area or do not reach 900 hPa. The curves look similar to the example in [Figure 69](#). Even without the boiling delay, these curves can be used for a reliable evaluation, especially when using the air entry values for evaluation.

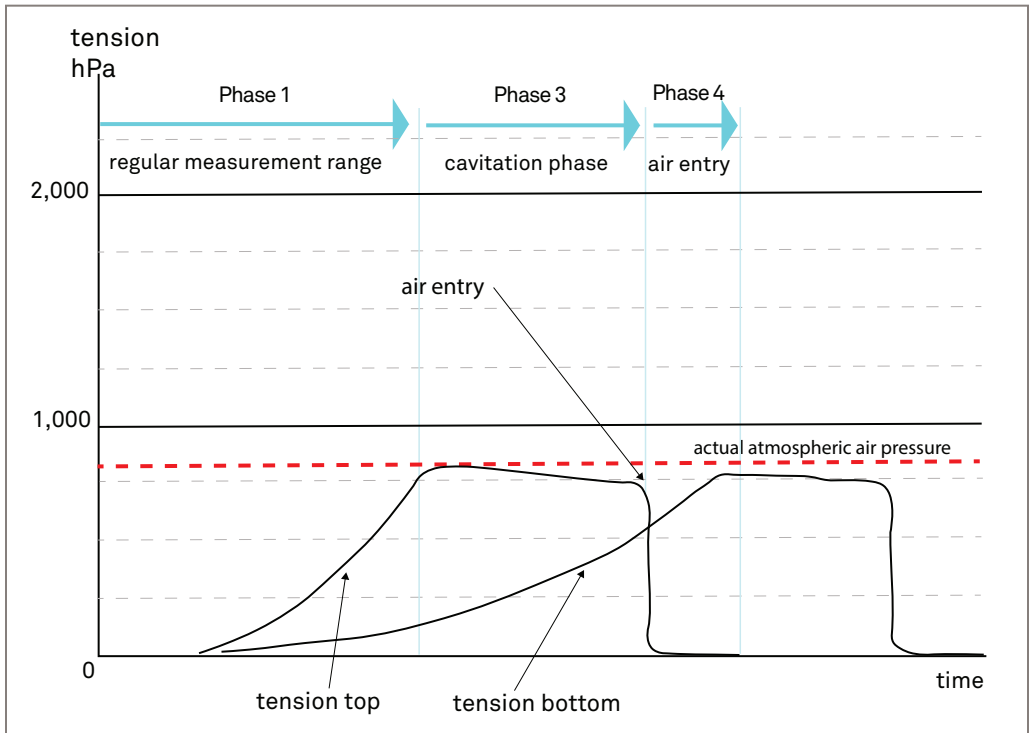

Figure 69 Suboptimal measurement curve

2.6.7 FINISHING A MEASUREMENT

The varying options of tensiometer shaft air entry values for additional measurement points will affect when to stop a measurement. All measurements must be stopped manually by selecting the respective STOP button in the software. The following descriptions and figures in this section show the different options.

There must always be two tension values to calculate the arithmetic mean of both tension curves for fitting (examples marked with a green x in [Figure 70](#) through [Figure 73](#)). One tension value for the upper tensiometer shaft and one for the lower tensiometer shaft (marked with a green dot in [Figure 70](#) through [Figure 73](#)).

OPTION 1: USING BOTH AIR ENTRY POINTS

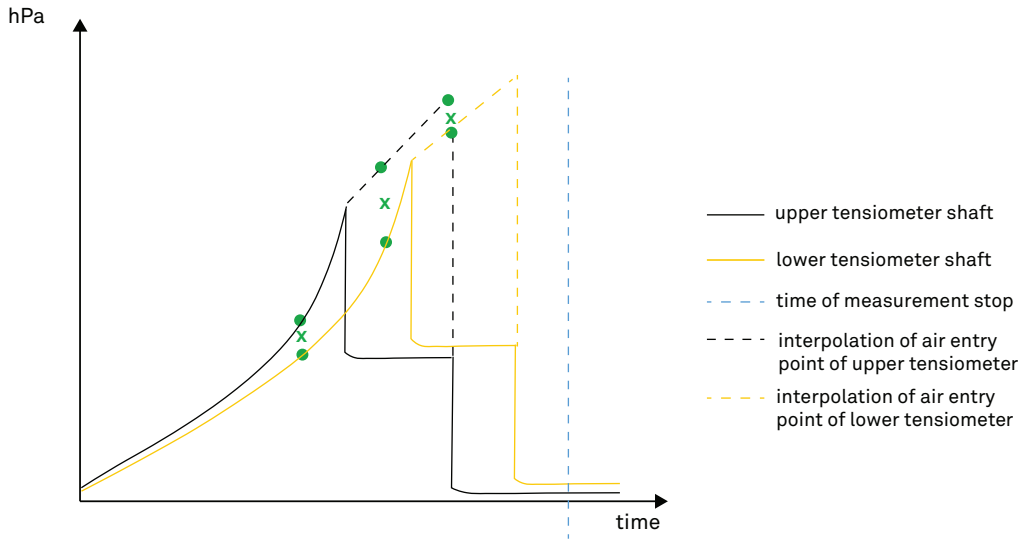

Figure 70 Stop measurement using both air entry points

In Figure 70, both tensiometers have reached the air entry point of the ceramic.

OPTION 2: USING ONE AIR ENTRY POINT

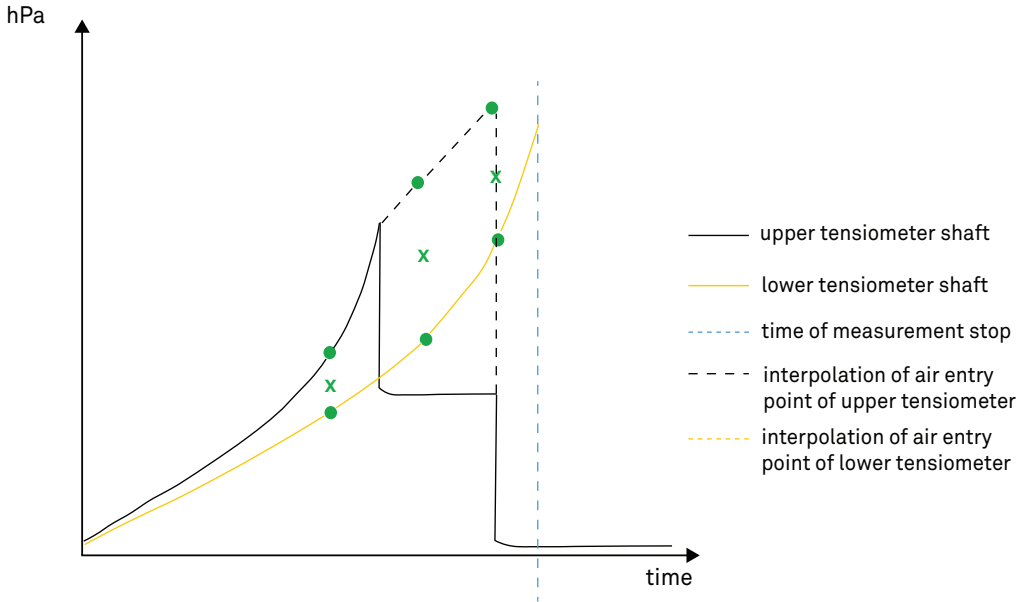

Figure 71 Stop measurement using one air entry point

The air entry point of the upper tensiometer is reached and the lower tensiometer is still in the regular measurement range or boiling delay where reliable data points can be generated (Figure 71).

OPTION 3: STOP WITHOUT USING AIR ENTRY POINTS

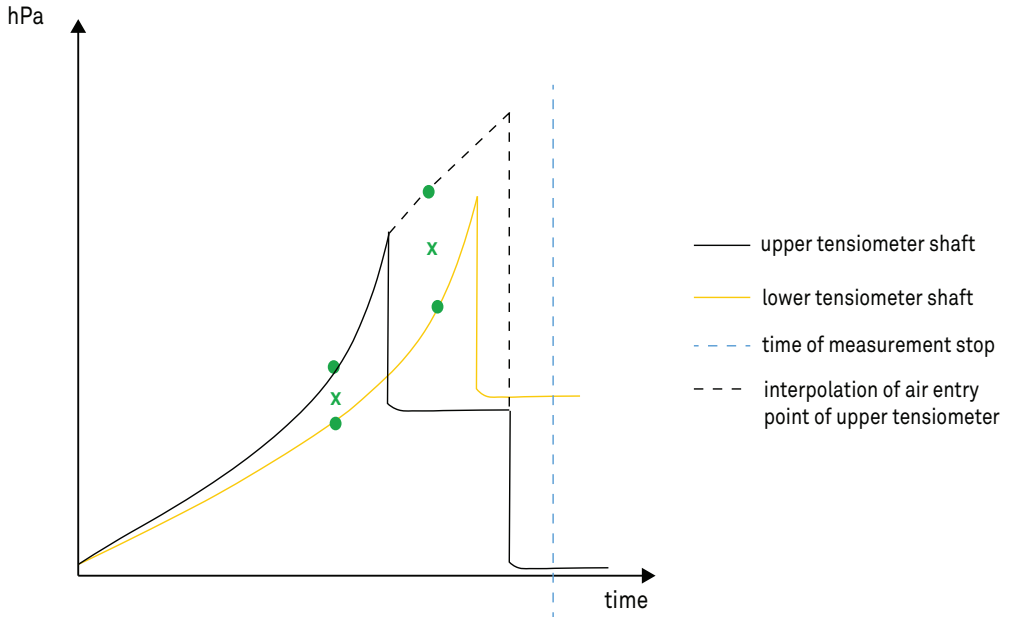

Figure 72 Stop measurement without using air entry points

Figure 72 shows the air entry point of the lower tensiometer has not been reached so the data point of the lower tensiometer is missing to generate the arithmetic mean with the air entry point of the upper tensiometer.

OPTION 4: STOP WITHOUT REACHING AIR ENTRY POINTS

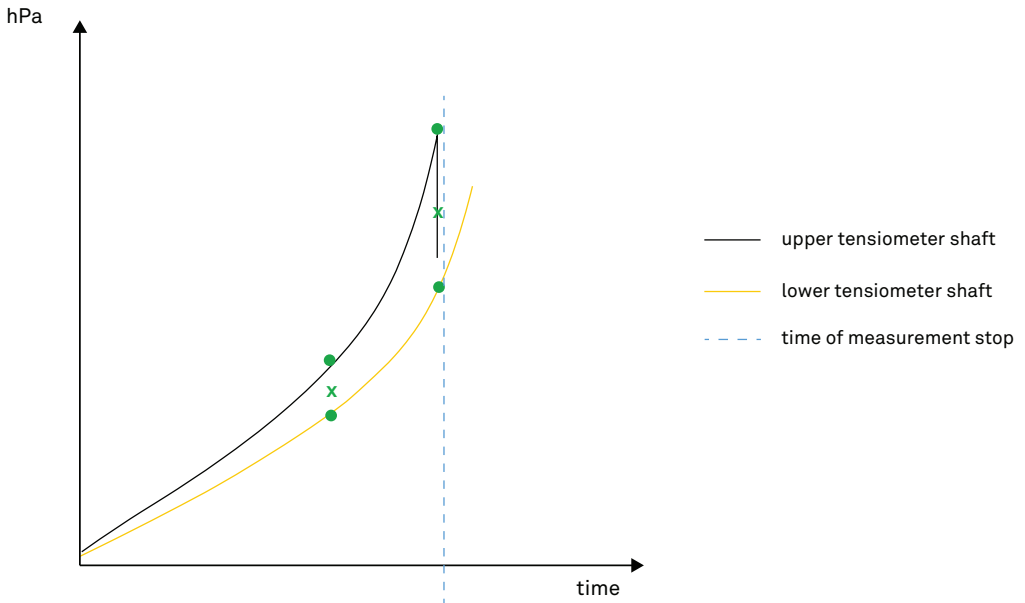

Figure 73 Stop measurement without reaching air entry point

Figure 73 no air entry point has been reached.

2.7 POSTPROCESSING

When the HYPROP measurement has been stopped, there are a few steps to consider for postprocessing. The following sections describe postprocessing steps.

2.7.1 EXTENSION OF THE MEASUREMENT RANGE

HYPROP measurements can be combined with WP4C® measurements to extend the soil water retention curve with data points in the dry range (–0.1 MPa to –300 MPa). Refer to [APPENDIX C](#) of this manual for how to process the soil sample to extend the measurement range and in combination with the WP4C. Also the WP4C product and support [page](http://meter.ly/WP4C) for more information on using the WP4C (meter.ly/WP4C)

2.7.2 DETERMINING DRY SOIL WEIGHT

The LABROS SoilView-Analysis software uses the dry soil weight to calculate initial water content and volumetric water content during evaporation. The dry soil weight is needed for calculations based on soil weight reduction during the evaporation process. This means the weight of the dry soil can only be determined after HYPROP measurement.

Determining dry soil weight steps:

1. Disconnect the HYPROP sensor unit from the balance or the tensioLink and place the whole system in a pan.
2. Open the clips and carefully remove the soil sample with the sampling ring from the HYPROP sensor unit.

Be careful not to break the tensiometer shafts.

NOTE: If the soil sticks too tight to the sensor unit and the tensiometer shafts (this often happens measuring clayey soils) put the whole system upside down in water. If necessary leave it in water overnight. The sampling ring can then be easily removed.

3. Note the tare weight of an oven-safe drying pan.
4. Use a brush to clean the tensiometer shafts, the silicone disc, and the soil sampling ring. Be sure to collect all soil particles in the drying pan.
5. Place the drying pan with the soil sample in the drying oven and let it dry for 24 h at 105 °C.
6. Take the drying pan out of the oven and weigh it.
7. Subtract the tare weight and note dry soil weight in LABRO SoilView-Analysis software.
8. Verify the weight of the soil sampling ring for evaluation in LABROS SoilView-Analysis software and all values to the respective HYPROP measurement in the software by checking the serial numbers of the sampling ring and the tensiometer shafts.

2.7.3 DISASSEMBLING AND CLEANING

Once the soil sample is disassembled the HYPROP sensor unit can be cleaned by following the steps below.

IMPORTANT: Always clean the HYPROP sensor unit upside down to make sure no soil particles are transported to the pressure sensors or in the sensor unit.

1. Remove the silicone disc and clean it under running water.
2. Clean the HYPROP sensor unit and the tensiometer shafts positioned upside down under running water (Figure 74).

Position the HYPROP upside down to prevent any debris or soil getting inside the sensor unit and damaging the unit.

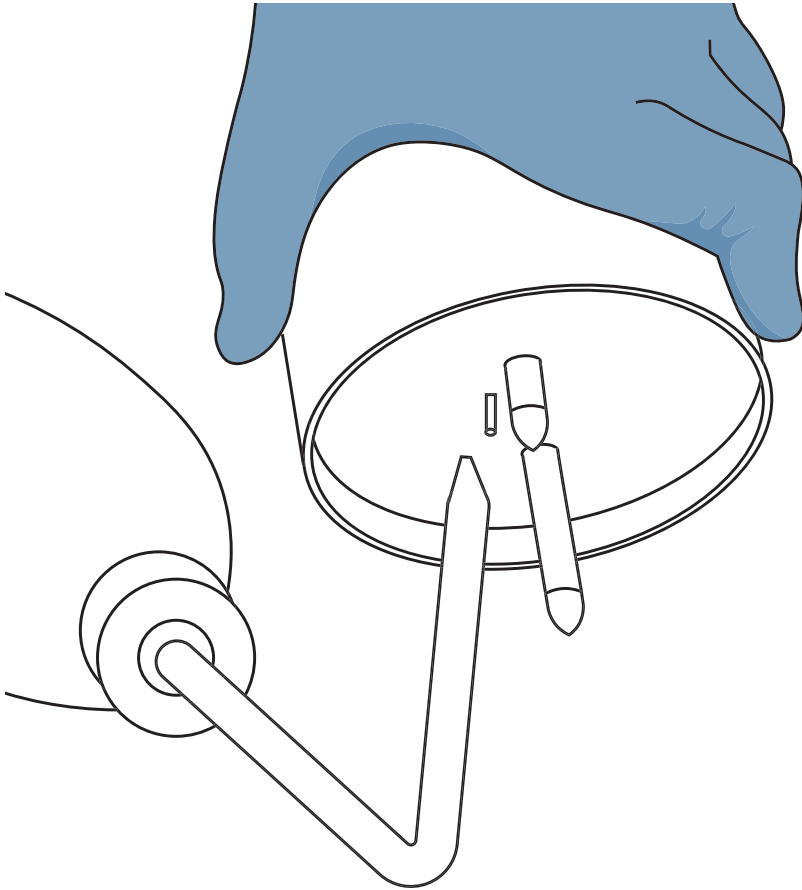

Figure 74 Clean the sensor unit positioned upside down with running water

3. Avoiding the ceramic tips of the tensiometer shafts, carefully dry the sensor unit with a cloth.
4. Unscrew the tensiometer shafts.
5. Hold the sensor unit upside down and use a washing bottle with distilled water to wash the surface of the sensor unit.
6. Use the washing bottle with distilled water to carefully rinse the shaft holes and remove particles.

Keep the sensor unit upside down while rinsing the shaft holes.

NOTE: The HYPROP sensor unit meets the protection class IP65 and can therefore be cleaned under running water with no danger.

It is important to clean the sensor unit every time a soil sample reading is completed for accuracy of future readings and the overall maintenance of the sensor unit.

2.8 DATA EVALUATION AND EXPORT

LABROS SoilView generates *.bhdX files that must be opened with the LABROS SoilView-Analysis software. Download LABROS SoilView-Analysis software from the HYPROP support page (meter.ly/hyprop-support).

LABROS SoilView-Analysis performs the following operations:

- Specification of all required parameters for the evaluation of the recorded experimental data with the Simplified Evaporation Method (SEM), such as column length, positions of tensiometers, tare weights of the measurement device components, the used steel rings, etc.
- Visualization of the raw data, i.e., tensions, weight changes, and specification of start and stop points for the data evaluation.
- Recalculation of tensions and net weight data used for the calculation of retention and conductivity data. This includes the temporal interpolation for data in low temporal resolution, and the aggregation of data in very high temporal resolution.
- Calculation and visualization of the data for the retention characteristic and the conductivity characteristic.
- Fitting of state-of-the-art hydraulic functions to the data, visualization of the functions, and listing of the values and confidence limits of the hydraulic parameters.
- Export of graphs, raw data, calculated data, fitted functions, and other parameters of interest.

The software guides the evaluation process with the registers **Information**, **Measurements**, **Evaluation**, **Fitting**, and **Export** (Figure 75).



Figure 75 LABROS SoilView-Analysis software registers

Information	Specifies the required parameters for the measurement
Measurement	Measured data visualization and editing
Evaluation	Calculates retention and conductivity data, and option to add externally measured data
Fitting	Fits hydraulic functions and parameters
Export	Exporting for data, graphs, function, and parameters

For more details about how to use LABROS SoilView-Analysis software, please read the LABROS SoilView-Analysis for HYPROP manual (meter.ly/hyprop-support).

3. SYSTEM

This section describes the specification, components, and theory of the HYPROP 2 system.

3.1 SPECIFICATIONS

MEASUREMENT SPECIFICATIONS

Measuring Range	
Pressure transducer	+3.0 hPa to -1000 hPa (-2400 hPa with boiling delay)
Temperature sensor	-20 to 70 °C
Accuracy	
Pressure measurement	1.5 hPa (using auto-zero calibration)
Temperature measurement	0.2 K (at -10 to 30 °C)
Resolution	
Pressure transducer	0.01 hPa
Temperature	0.01 °C
Volume of Soil	
250 cm ³ / 100 cm ³	
Measurement Interval (default)	
10 min	
Number of Sensor Units	
Multi-balance mode	Max. 20 balances and sensor units / max. 10 per USB hub
Single-balance mode	Max. 20 per HYPROP USB adapter

COMMUNICATION SPECIFICATIONS

Power Requirements	
Voltage	6-10 V DC
Current	mA nominal, 15 mA max.
Computer Compatibility	
Microsoft Windows 10 or newer	

PHYSICAL SPECIFICATIONS**Sensor Unit**

Material	POM
Dimensions	Height 63 mm, Ø 80 mm

Tensiometer Shaft

Ceramic	Al ₂ O ₃ sinter, air-entry point > 200 kPa; Ø 5 mm
Shaft material	Acrylic glass; Ø 5 mm
Total length	Short shaft: 31 mm; Long shaft: 56 mm

Polyurethane Tubing

Outer diameter	6 mm
Inner diameter	4 mm
Length	0.3 m

Protection

Housing with covered plug	IP 65 splash waterproof
---------------------------	-------------------------

Chemical Resistance

pH range	pH 3 – pH 10
----------	--------------

Operating Temperature

10 °– 30 °C

Required External Measurements

Dry soil weight
Air-entry value of tensiometer shafts

LABROS Balance

Connection to computer	USB
------------------------	-----

Weighing Range

2200 g

Readout

0.01 g

Reproducibility

0.01 g

Linearity

0.01 g

Adjustment

Internally

COMPLIANCE

EM ISO/IEC 17050:2010 (CE Mark)

3.2 COMPONENTS

The HYPROP measurement system consists of the following components:

- the HYPROP sensor unit set
- the sample preparation set
- the HYPROP refill unit set
- the LABROS Balance
- the HYPROP USB adapter set

The HYPROP device consists of two pressure transducers mounted in the HYPROP sensor unit. A temperature sensor is located on the surface of the sensor unit. The sensor unit is connected to a LABROS Balance or to a USB adapter. The pressure and temperature signals are processed in the sensor unit and the signals are transferred to a computer via a USB connection. The weight measurements (done manually or automatically) are transferred to a computer via a USB connection with the balance ([Figure 76](#)).

SYSTEM

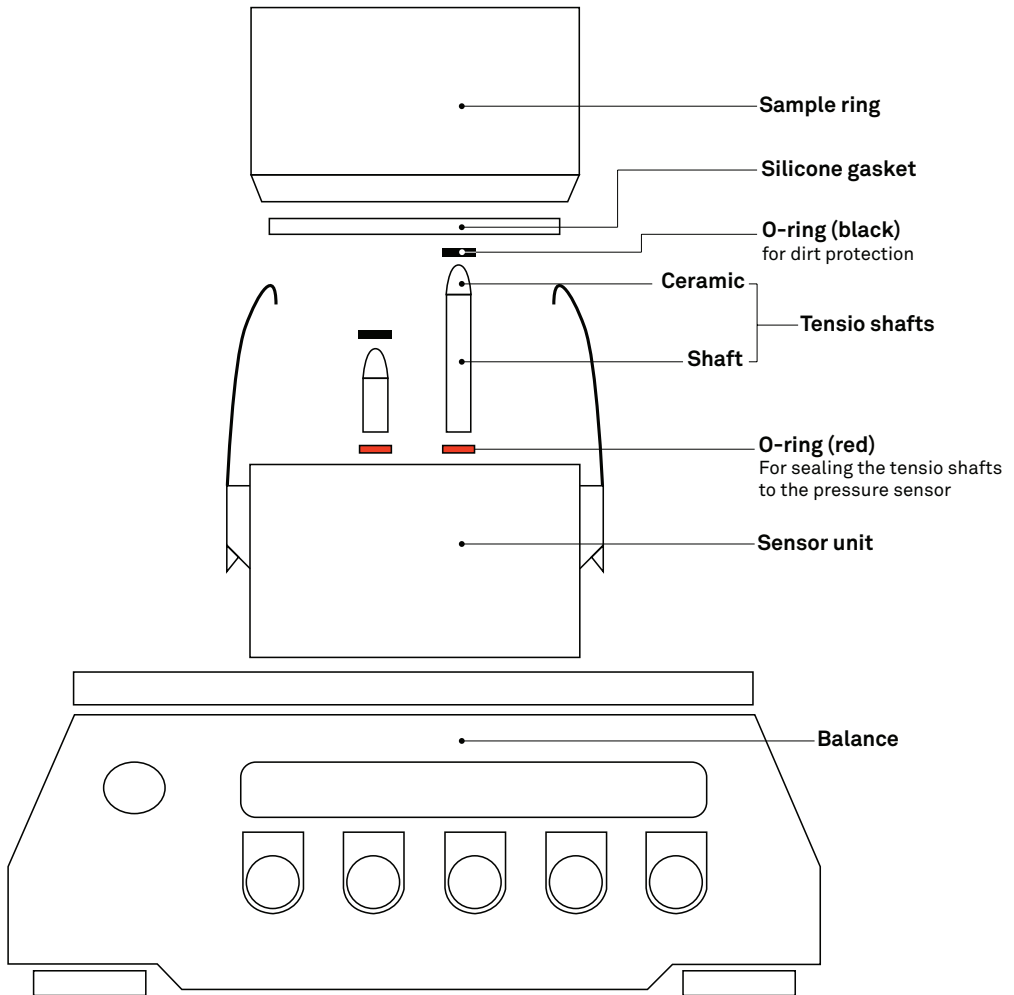

Figure 76 HYPROP system and LABROS Balance

3.2.1 LED INDICATOR

The status of the instrument is indicated by the LED ring indicator on the measurement head.

MULTI-BALANCE MODE

White flashing three times	HYPROP detected by the computer via LABROS Balance.
White constant	HYPROP detected by LABROS SoilView software and can be configured for measurement.
White flashing	HYPROP is ready for measurement.
Blue pulsing	Measurement is in progress.
Blue pulsing with higher frequency	Measurement is finished.
Red permanent	Firmware is being updated

SINGLE-BALANCE MODE

White flashing three times	HYPROP detected by the computer via HYPROP USB adapter.
White constant	HYPROP detected by LABROS SoilView software after using the option Show devices , and is ready to be configured for measurement.
White flashing	HYPROP is ready for measurement.
Blue pulsing	Measurement is in progress.
Blue pulsing with higher frequency	Measurement is finished.
Red permanent	Firmware is being updated

3.2.2 CHANGE DEVICE IDENTIFICATION (ID)

If more than one HYPROP sensor unit is used at the same time (single-balance mode or Multi-balance mode), every sensor unit is required to have a unique device ID. Naming each sensor unit with its own ID prevents errors in device detection and the need to troubleshoot.

Please follow the instructions below to check device ID and if applicable change the device ID.

1. Connect one HYPROP sensor unit.
2. Check the device ID by putting the cursor over the sensor unit shown in the device tree on the left in the software screen ([Figure 77](#)).

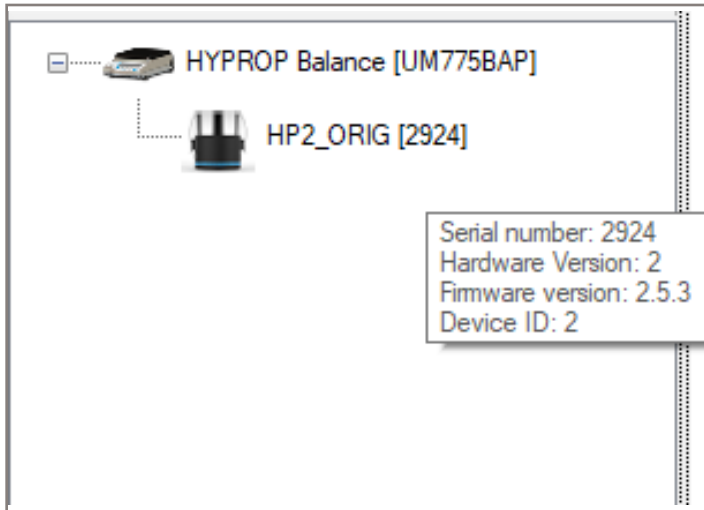

Figure 77 Check device ID

3. For changing the device ID select the sensor unit with a right mouse click.
4. Select **Change Device ID** (Figure 78).

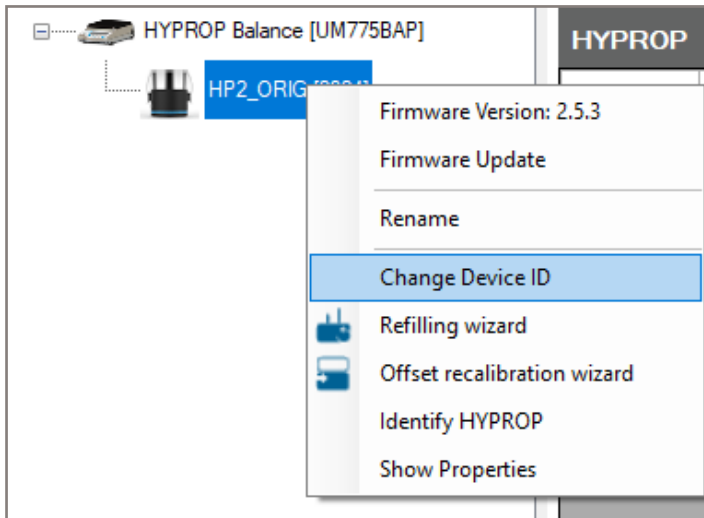

Figure 78 Change Device ID

5. Change the device ID and save the change by selecting **Apply**.

There is also the opportunity to change a device name. To do so, select the option **Rename** in the dropdown menu (Figure 78).

3.2.3 TUBE CONNECTIONS

To avoid any leakage in the connections, always cut the tube straight across and not angled (Figure 79).

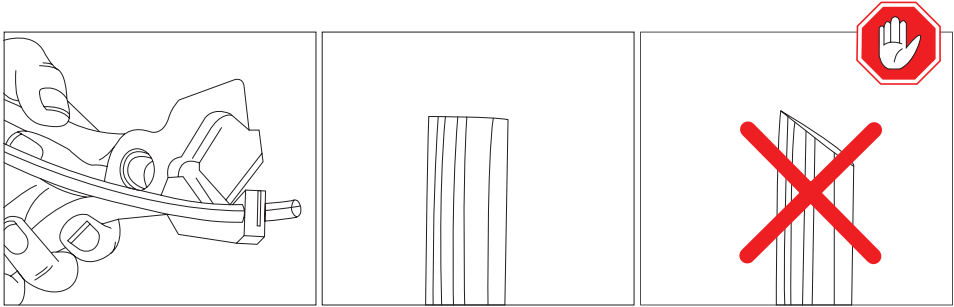

Figure 79 Cutting the tube

To connect the tube to the fitting, push it until it latches (Figure 80).

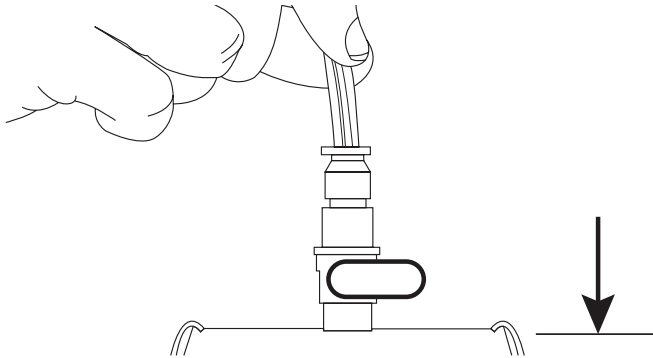

Figure 80 Connecting the tube

To remove the tube press the blue ring and pull (Figure 81).



Figure 81 Removing the tube

3.2.4 ADDITIONAL FUNCTIONS OF LABROS SOILVIEW SOFTWARE

The Main menu toolbar (Figure 82) contains main actions in the software. Table 7 describes the Main menu options.

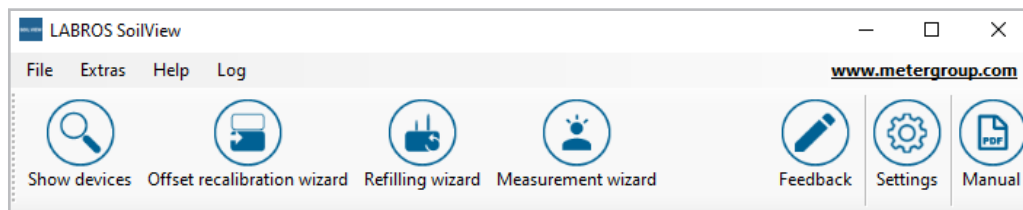

Figure 82 Main menu toolbar

Table 7 Main menu options

Main Menu Options	Descriptions
File	Close the application
Extras	Open the Refilling Wizard, the Measurement Wizard, or the Update Wizard
Help	Open a Quick Start Guide, the User Manual, Help Folder, check for Updates, and Info
Log	Open Error messages and tother logbook entries.
Show devices	Shows when connecting more devices in a row to one tensioLink cable (to be used when measuring in One balance for more HYPROP's mode) LABROS SoilView software normally automatically shows all directly connected devices.
Offset Recalibration Wizard	Detects offset deviations and sets the zero point (see Section 2.5.4)
Refilling Wizard	Assists when refilling the HYPROP (see Section 2.5)
Measurement Wizard	Displays a menu to help start a measurement and select the right adjustments
Feedback	Provides feedback
Settings	Adjust general settings and define measurement profiles for the HYPROP measurements For more information refer to Section 2.2
Manual	View the current manual

3.2.5 CONTINUING A MEASUREMENT AFTER STOPPED OR COMPLETED

A measurement that is completed or has accidentally been stopped can be continued. To continue a measurement, follow the steps below:

1. Select the **...** button next to the **File name** field in the measurement line (Figure 83).



Figure 83 Open measurements to continue

2. Select the measurement to be continued.
3. Press **Save**.
4. Select whether the measurement should be continued or overwritten.

NOTE: When continuing a measurement, the same device has to be used because the weight of the device is a critical parameter for the evaluation. A different balance may be used when continuing a measurement, as that will not adversely affect the data.

3.3 THEORY

PRELIMINARY NOTE

HYPROP (HYdraulic PROProperty analyzer) is a device to measure hydraulic key functions of soil samples in a convenient and reliable way using an evaporation method.

Wind (1966) developed the evaporation method in the mid-sixties using five tensiometers placed into a soil sample, set on a balance. The samples' tensions and mass change were measured in time intervals throughout the evaporation process. Based on these data, the water retention function and the unsaturated hydraulic conductivity in the range between saturation and maximum 500 hPa (50 kPa) were calculated employing an iteration process.

Schindler (1980) simplified this method. He used only two tensiometers and simplified the evaluation procedure. HYPROP is based on this method. Schindler's methods were tested several times and proved fit for use by scientific analysis (Wendroth et al., 1993; Peters and Durner, 2008; Peters et al., 2015). Later research results yielded a further simplified measuring procedure (Schindler and Mueller, 2006) and an extended measuring range (Schindler et al., 2010a and Schindler et al., 2010b). Using the HYPROP simultaneously measures the water retention curve and the unsaturated hydraulic conductivity function in the range between water saturation and close to the permanent wilting point. The measuring time duration varies depending on the soil, from two days (clay samples) to a maximum of 10 days (peat and sand samples). Additionally, the dry bulk density of the sample is determined.

The HYPROP measurement and evaluation has two modes: multi-balance mode and single-balance mode. In the multi-balance mode (one balance per sample), the lab employees' workload is streamlined: it only requires setting up and taking away the samples. In the single-balance mode (one balance for more samples), up to 20 samples can be measured in parallel. In this mode, it is necessary to manually put the probes on the balance at least twice daily. This takes about 15 s per sample and weighing. The measurement of the tension

runs automatically. The software LABROS SoilView enables convenient data logging and storage. LABROS SoilView-Analysis software provides the same ease for data evaluation, fitting, and export of the hydraulic key functions. The hysteresis of the saturation and dewatering characteristics of the hydraulic key functions is described in Schindler et al. (2015).

Measurements considering the shrinkage characteristics of the soil sample are described in Schindler et al., 2015. Comparing the measuring results of HYPROP and classical methods (sand box, kaolin box, pressure pot) demonstrated good congruence (Schelle et al., 2010, 2011, 2013a, b; Schindler et al., 2012). Systematic differences could not be found.

3.3.1 MEASURING METHOD

HYPROP 2 measures the relationship between water content and water potential in the soil matrix. Water content is defined as the amount of water in a known amount of soil. This can be measured on either a mass basis (gravimetric water content) or a volumetric basis (volumetric water content).

Water potential is defined as the amount of energy required to move a volume unit of water from the sample compared to a sample of free water (pure water not bound to a soil matrix). In other words, water potential is the amount of energy a plant must exert to remove water from the soil. Water in a soil matrix is bound to the soil particles, diluted by solutes, and under pressure. Water potential is commonly expressed in units of pressure, such as kilopascals (kPa) or hectopascals (hPa). Another typical measurement unit is potential force (pF), which uses a scale to represent the energy state of water ranging from saturation (0) to permanent wilting point (4.2). Water potential is also often called suction, pressure, or tension.

The HYPROP 2 also measures unsaturated hydraulic conductivity based on the evaporation method developed by Wind (1968) and modified by Schindler (1980). The relationship between water potential and water content determines hydraulic conductivity. This relationship is often called a soil moisture release curve, soil-water retention curve, or soil-water characteristic curve.

Using two tensiometers positioned at different depths in a soil sample (with a known sample volume ring), HYPROP 2 measures hydraulic conductivity (Figure 85 and Figure 86). The soil between these two tensiometers represents the center of the soil sample. The sample is saturated with water, closed on the bottom, and placed on a balance. The top surface of the soil sample is left open to the atmosphere to allow evaporation of the soil water. The HYPROP then measures the weight of the soil over time and uses this information to calculate the water content of the soil. The water potential value of the soil is determined by averaging the readings of the two tensiometers.

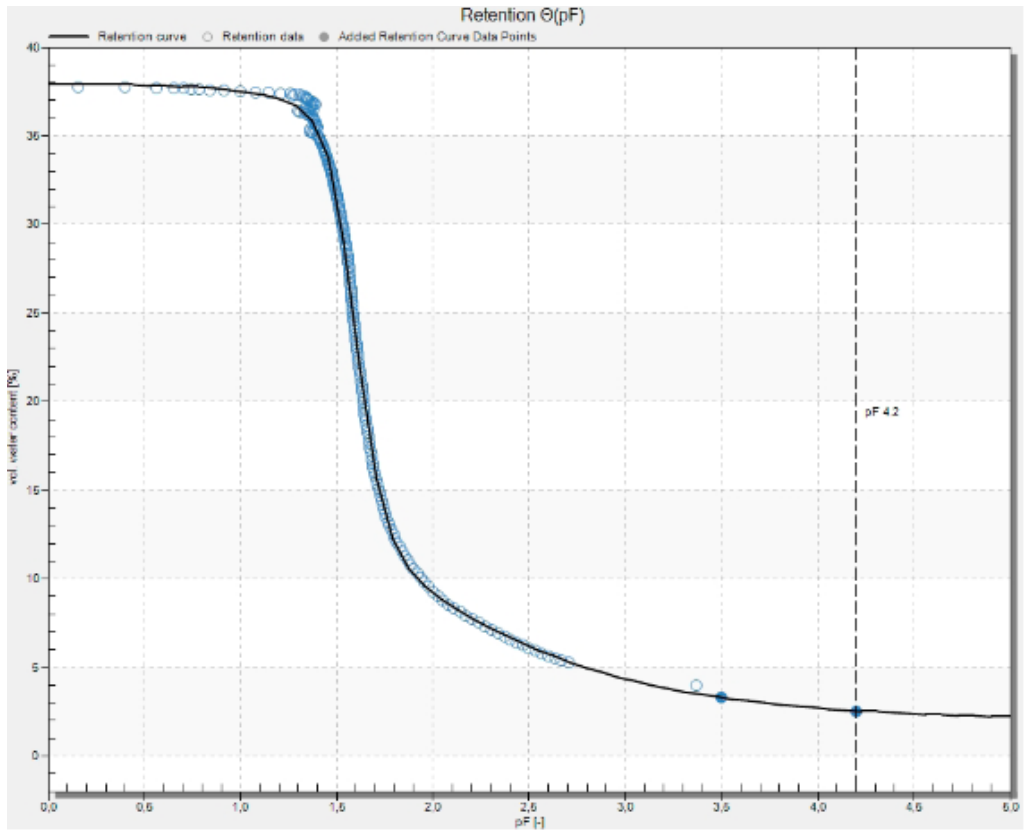

Figure 84 Typical retention curve of sand

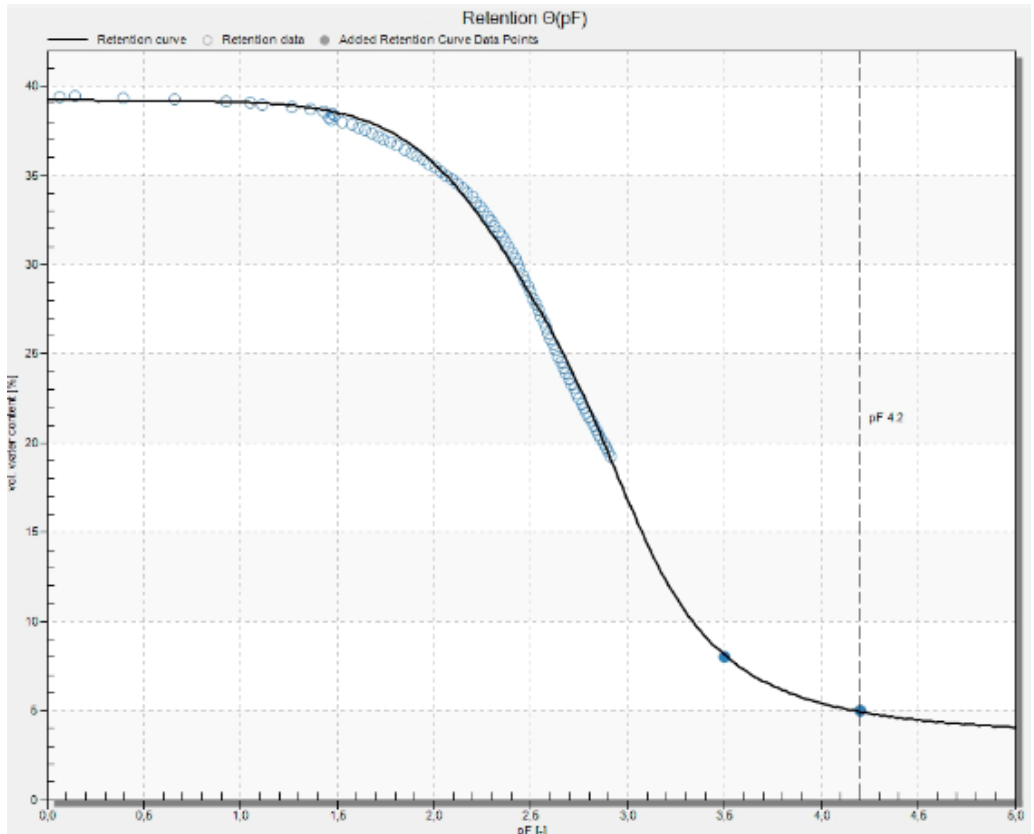

Figure 85 Typical retention curve of loam

The water inside the tensiometer shafts is sealed and separated from the soil by a porous ceramic tip. The ceramic tips are designed to mimic the pore size distribution of the soil matrix and allow water to flow in or out of the shaft based on the pressure differential of the soil matrix. This pressure is measured by an extremely sensitive pressure transducer in the HYPROP 2 housing. As the soil sample dries, more water is pulled out of the tensiometer shafts until the pressure reaches cavitation and an air bubble is formed in the water column. At this point, the measurement is over. After stopping the measurement process (Section 2.6.7), the evaluation process begins.

3.3.2 GENERATING DATA POINTS

HYPROP 2 measures the water tensions h_1 and h_2 (in hPa or kPa) in two measuring levels of the sample at certain points of time, t being defined in the LABROS SoilView software configuration. In the multi-balance mode the total mass of the sample is also weighed in g at the same time. In the single-balance mode the sample mass is weighed manually, usually twice a day. The LABROS SoilView software calculates the medial water content of

the sample based on the sample mass minus all tare components (sensor unit, sample ring, dry mass of the soil). The dry mass of the soil can be determined after the measurement by drying the sample in an oven at 105°C (Section 2.7.2).

The measuring data are evaluated with the LABROS SoilView-Analysis software according to Schindler's method (1980). The precise calculation of the water content needs the input of the soil's dry mass. As long as the dry mass has not been entered, LABROS SoilView-Analysis estimates the water content upfront. Based on linearization assumptions LABROS SoilView-Analysis calculates discrete points of the retention and the conductivity curves. For this, the raw data are interpolated by Hermitian splines which provides the advantage of differing measuring times of tensions and water contents that can be adjusted. Another advantage is the number of spline points used for calculating data are fixed a priori. The default set in LABROS SoilView-Analysis is a calculation at 100 data points that are taken from the splines. Please refer to the LABROS SoilView-Analysis [manual](#) (meter.ly/hyprop-support) for more information.

At every calculation spline point a medial water content θ_i is calculated by dividing the mass of the soil water by the volume of the soil body. Each of these points are assigned to a tension that is calculated from the measured and averaged tensions h_1 and h_2 . Finally, this procedure results in 100 points of the retention curve $\theta_i(h_i)$.

In order to calculate the conductivity function it is assumed that the water flows through a horizontal plane that lies exactly in the middle of the two tensiometer shafts (and thus in the symmetry plane of the column) between two spline points t_{i-1} and t_i

$$q_i = 1/2(\Delta V_i/\Delta t_i)/A \quad \text{Equation 1}$$

with ΔV_i being the water reduction (cm^3) over the mass change, Δt_i the time interval between two calculation spline points and A the cross-sectional area (cm^2) of the column. The data points for the hydraulic conductivity function are calculated by inverting Darcy's equation:

$$K_i(h_i) = -q_i/((\Delta h_i/\Delta z) - 1) \quad \text{Equation 2}$$

With h_i being the time- and space-averaged tension, Δh_i the difference of the two tensions at the two measuring levels, and Δz the distance of the measuring levels (i. e. the height difference of the tensiometer shafts).

LABROS SoilView-Analysis filters the unreliable $K(h)$ data pairs near saturation depending on the measuring accuracy of the tensiometer shafts (Peters and Durner, 2008). After this parametric functions $\theta_i(h_i)$ and $K_i(h_i)$ are adjusted to the measuring points $\theta(h)$ and $K(h)$ gained by non-linear optimization. In LABROS SoilView-Analysis the user can select the type of function; all usual models can be found (van Genuchten, 1980; Brooks and Corey, 1964; Kosugi, 1996; Fredlung-Xing, 1994) in uni- and bi-modal form as well as in a more sophisticated modeling as Peters-Durner-Iden (PDI) variant (Peters, 2013; Iden und Durner, 2014). The complete description of the evaluation procedure as well as the models and the curve fitting can be found in the LABROS SoilView-Analysis manual (meter.ly/hyprop-support) and in Peters et al., (2015).

PARAMETER OPTIMIZATION

The $\theta(h)$ and $K(h)$ functions are adapted simultaneously to the data points. This is essential as distinct parameters (i. e. α and n) influence the shape of both functions (van Genuchten/Mualem). The adaptation is accomplished by a non-linear regression under minimization of the sum of all assessed squares of the distance between data points and model forecast. However, the assumption that water content is spread out linear over the column is not always fulfilled in coarse, pored or structured soil. Therefore, the so-called “integral fit” is applied for the adaptation of the retention function to avoid a systematic error (Peters and Durner, 2006). For details of the fitting procedure and data assessment please refer to Peters and Durner (2007, 2008) and Peters et al., (2015).

3.3.3 ADDITIONAL NOTES

Influences on the measuring range, the air entry point of the tensiometer shaft, water vapor pressure, and the Osmotic effect are covered in this section.

INFLUENCES ON THE MEASURING RANGE

Three factors limit or extend the measuring range of the tensiometer shafts:

- the air entry point
- the water vapor pressure (boiling point)
- the boiling delay

THE AIR ENTRY POINT OF THE TENSIO METER SHAFT

This value is specific for a porous hydrophilic structure and depends on the contact angle and the pore size. The air entry point of the METER tensiometer shafts is about 8.8 bars so it does not limit the measuring range.

WATER VAPOR PRESSURE

At a temperature of 20°C the vapor pressure of water is 2.3 kPa above vacuum. This means if the atmospheric pressure is 100 kPa at 20°C the water will start to boil or vaporize as soon as the pressure drops below 2.3 kPa (= 97.7 kPa pressure difference). At this point the limit of the measuring range of the tensiometer is reached.

Please note that the atmospheric pressures announced by meteorological services are always related to sea level. However the true atmospheric pressure at an elevation of 500 meters above sea level is for example only 94.2 kPa (although 100 kPa are announced). In this case the measuring range at 20°C is limited to -91.9 kPa. Even if the soil gets drier, the tension shown by the readout will remain at this value. But as soon as the bubble point is reached, a spontaneous compensation with the atmospheric pressure occurs. Then air enters the tensiometer shaft and the readout will rapidly drop to zero.

OSMOTIC EFFECT

The ceramic has a pore size of $r = 0.3 \mu\text{m}$ and therefore cannot block ions. Thus, an influence of osmosis on the measurements is negligible. If the tensiometer shaft is dipped into a saturated NaCl solution the readout will show 1 kPa for a short moment, then it will drop to 0 kPa again.

4. SERVICE

This section contains calibration and recalibration information, calibration frequencies, cleaning and maintenance guidelines, troubleshooting guidelines, customer support contact information, and terms and conditions.

4.1 CALIBRATION

Each HYPROP device is pressure calibrated after manufacturing. In case of errors, LABROS SoilView will give a warning message to send the HYPROP back for an inspection by METER (See [Section 2.5.4](#)). Contact [Customer Support](#) with questions.

4.2 CLEANING AND MAINTENANCE

HYPROP should be cleaned after each use. Follow the steps in [Section 2.7.3](#) for cleaning the HYPROP sensor unit.

Replacement parts are available to order from METER Group. Contact [Customer Support](#) for more information.

4.2.1 CHANGING THE O-RING IN THE SENSOR UNIT

When the tension value of a tensiometer shaft flattens significantly during measurement ([Figure 86](#)) or drops before reaching vacuum (800 hPa), this is an indication for leakage. In this case, changing the red O-rings in the sensor unit is recommended.

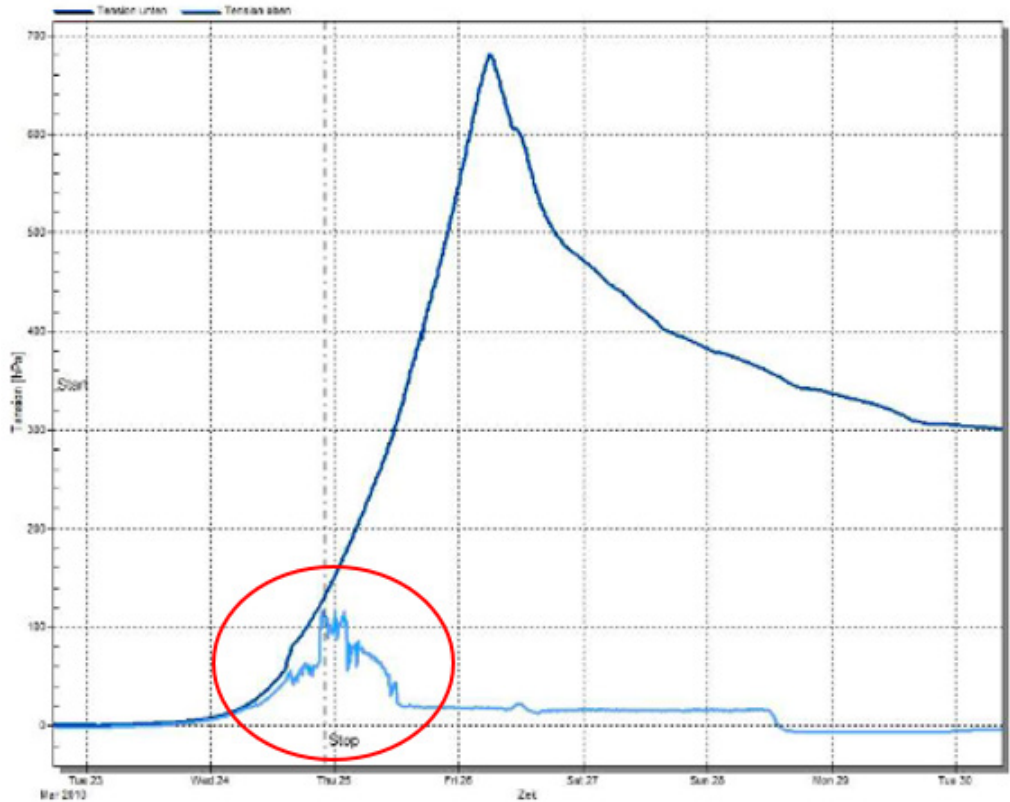

Figure 86 Flattening measurement curve

Changing the O-ring use fine-pointed tweezers:

1. Pierce the O-ring with tweezers to pull it out (Figure 87).

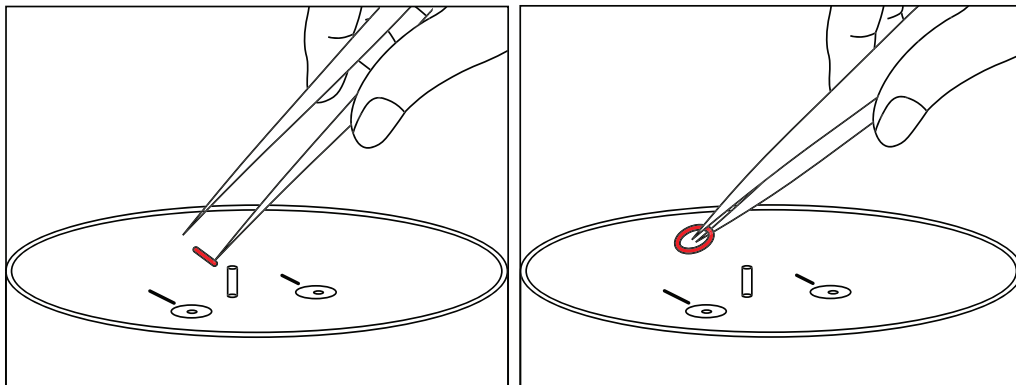

Figure 87 Changing the O-ring

2. Take a new O-ring from the service package.

IMPORTANT: Do not pierce the new O-ring.

3. Place the O-ring in the hole and fit it into the groove on the bottom of the hole.

If the O-ring cannot be easily placed in the groove, carefully screw in the tensiometer shaft to position the O-ring.

NOTE: Do not stick the tweezer tips into the hole of the sensor unit. This may damage the pressure transducer.

4.2.2 STORAGE

If the HYPROP 2 will not be used for a long time, algae growth must be avoided with proper storage. To prevent algae growth, empty the sensor unit as well as the tensiometer shafts by slightly knocking on the bottom of the sensor unit. Place a covering on the sensor unit to protect the holes from dust. Store all components dry.

4.3 TROUBLESHOOTING

Table 8 lists common problems and their solutions. If the problem is not listed or these solutions do not solve the issue, contact [Customer Support](#).

Table 8 Troubleshooting the HYPROP 2

Problem	Possible Solutions
The tensiometer shaft is dry	Fill the tensiometer shaft with deionized water by either using syringes (Section 2.5.3) or the METER Refill Unit (Section 2.5.2).
Air bubbles can be seen in the tensiometer shaft	Repeat the refilling process. If this does not help, try to detect possible leakage by replacing the red O-ring of the tensiometer shaft (Section 4.2.1).

Table 8 Troubleshooting the HYPROP 2 (continued)

Problem	Possible Solutions
The tension value only reaches 500–700 hPa (50–70 kPa) and then drops	<ol style="list-style-type: none"> 1. Tensiometer shaft has not been filled air free (Section 2.5.1). 2. Red O-ring of the tensiometer shaft does not seal properly. Check and replace O-ring if necessary (Section 4.2.1).
The tension value of the bottom tensiometer shaft stops at 200 –700 hPa and then drops	<ol style="list-style-type: none"> 1. The soil sample is disrupted horizontally. The gap was initially filled with water and later on with air. 2. Tensiometer shaft has not been filled air free (Section 2.5.1). 3. Red O-ring of the tensiometer shaft does not seal properly. Check and replace O-ring if necessary (Section 4.2.1).
The value of the tensiometer shafts exceeds the value of the atmospheric pressure (e.g., 1000 hPa/100 kPa)	This is not an error. It is the physical effect of boiling delay. HYPROP 2 measures beyond the normal range possible (Section 2.6.5).
Measuring data is no longer recorded	<ol style="list-style-type: none"> 1. Check the connection to the USB port. 2. Check the energy management on the computer used to log the data. Change the energy management to Continuous Operation. This is a common problem when using a laptop to log data.
The value of the bottom tensiometer is higher as the value of the upper tensiometer shaft	<p>Check the tensiometer shafts for incorrect placement during refilling. There is no need to interrupt the measurement. It can be corrected in LABROS SoilView-Analysis software.</p> <p>If tensiometer shafts are placed correctly and the value of the bottom tensiometer is higher value than the upper tensiometer shaft, contact Customer Support.</p>
In single-balance mode the software does not find any sensor units	Disconnect and connect the sensor units one by one. Do this to check for one or more sensor units with the same device ID. If this is the case, change the device ID (Section 3.2.2).
The software monitors tension values of 4000 hPa	The pressure sensors have been destroyed. The sensor unit must be checked and repaired. Please contact Customer Support for sending the device to METER for repair.

4.4 CUSTOMER SUPPORT

NORTH AMERICA

Customer service representatives are available for questions, problems, or feedback Monday through Friday, 7:00 am to 5:00 pm Pacific time.

Email: support.environment@metergroup.com
sales.environment@metergroup.com

Phone: +1.509.332.5600

Fax: +1.509.332.5158

Website: metergroup.com

EUROPE

Customer service representatives are available for questions, problems, or feedback Monday through Friday, 8:00 to 17:00 Central European time.

Email: support.europe@metergroup.com
sales.europe@metergroup.com

Phone: +49 89 12 66 52 0

Fax: +49 89 12 66 52 20

Website: metergroup.de

If contacting METER by email, please include the following information:

Name	Email address
Address	Instrument serial number
Phone	Description of the problem

NOTE: For products purchased through a distributor, please contact the distributor directly for assistance.

4.5 TERMS AND CONDITIONS

By using METER instruments and documentation, you agree to abide by the METER Group, Inc. Terms and Conditions. Please refer to metergroup.com/terms-conditions for details.

APPENDIX A. DETERMINING AIR ENTRY VALUE

As mentioned in [Section 2.7.1](#) it is possible to extend the range of the tensiometric measurements by using the air entry value of the ceramic tensiometer tip as an additional measuring point (Schindler et al., 2010). The default air-entry value of 8.8 bar is the statistical mean of ceramic tips used in the 2010 series of METER HYPROP tensiometers. This value changes with time and use. Verify the value using the procedure described below.

The following safety information must be strictly followed:

- Read all applicable safety instructions completely and carefully and always follow the recommended safety instructions, especially the user manual and the safety data sheet of the used compressor.
- Do not use any device if the electrical wire is damaged.
- Always use safety glasses when working with overpressure.
- Always check all connections before applying overpressure.

METER Group is not liable for equipment not manufactured by the METER Group.

The following set-up for determining the air-entry points of the ceramic tips is a suggestion and can of course be adapted to the available lab equipment.

- Container filled with distilled water
- Equipment to mount the shaft refilling adapters ([Figure 88](#))
- Shaft refilling adapters including tubes (e.g., from HYPROP refill unit beaker mount)
- Compressor (capable of 7 bar –12 bar pressure) including connection tubes and pressure gauge (resolution: 0.01 bar)
- Safety glasses and rubber gloves
- Timer
- Magnifying glass

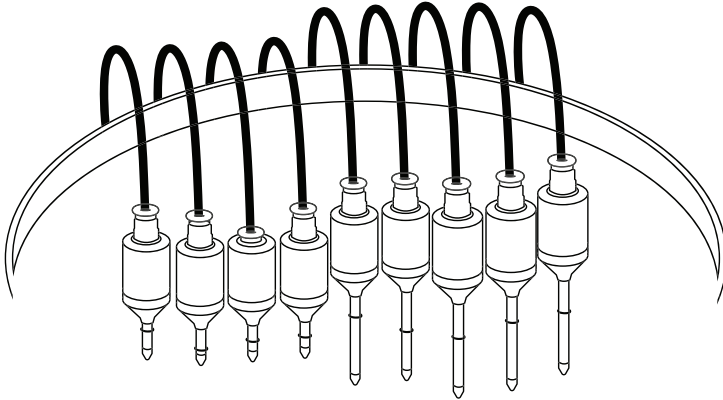

Figure 88 Determining air-entry point

1. Clean the ceramic tip carefully with a brush under running water.
2. Place the tensiometer shafts for testing 24 h in a beaker filled with distilled water to saturate the ceramic tip.
3. After saturation, completely empty the tensiometer shafts.
4. Screw them in the refilling adapters and place them in the water filled container.
5. Turn on the compressor and slowly set the value to 7.0 bar.
6. Set the timer to two minutes.
7. After two minutes use the magnifying glass to check if there are any air bubbles coming out of the ceramic.

If there are no bubbles, slowly set the value to 7.5 bar and wait another two minutes.

If there are bubbles, note the current value of the applied pressure as the air-entry point of the tensiometer shaft and note the serial number of this shaft to assign it to the respective HYPROP measurement for evaluation.
8. Increase the pressure by 0.5 bar increments every two minutes until all tensiometer shafts show air bubbles.

If the air-entry point is higher than 12.0 bar, replace the tensiometer shaft because the pores of the ceramic have likely become clogged.
9. Release the pressure to 0 bar and unscrew the tensiometer shafts using rubber gloves.

The measured air-entry values can now be assigned to the respective HYPROP measurement by using the serial number of the tensiometer shaft and entered in the LABROS SoilView-Analysis software (in the register **Information**) for evaluating the HYPROP measurement more precisely.

APPENDIX B. EXAMPLE MEASUREMENT RESULTS

Sandy loam (Ls3) example:

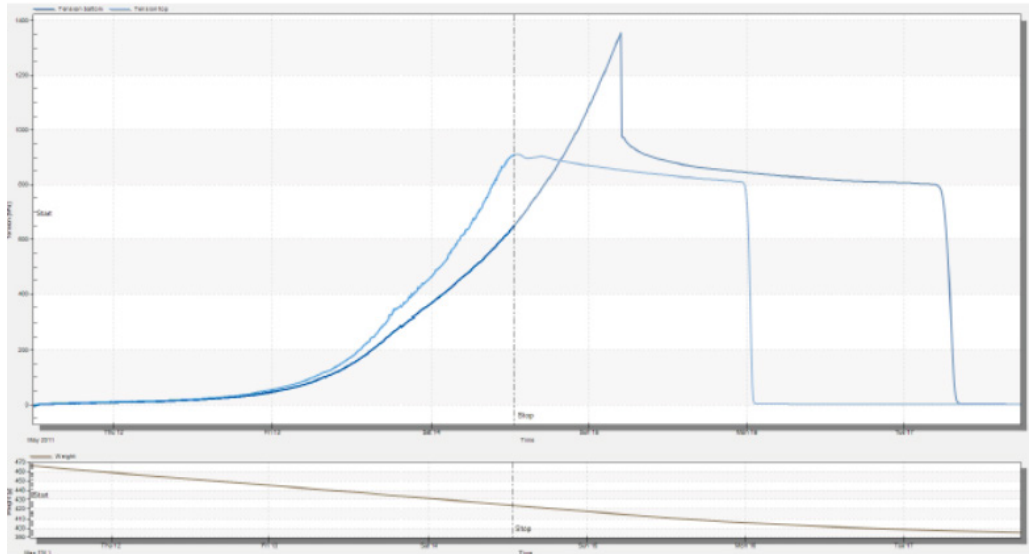

Site: Wolfenbüttel; soil type: slightly sandy loam. Ls3 (S 35%, U 48%, T 17%); measurements in winter 2011 at "Geoökologische Labormethoden 2011", TUBraunschweig. Evaporation: 2,75 mm/d, temperature: 21°C

Figure 89 Example measurement sandy loam

This measurement process is typical for clay soils with wide pore size distribution. The water tensions rise continuously for almost two days, but at a moderate slope. This reflects a large pore fraction in clay of almost 10%.

From approximately 50 hPa (pF 1.7), the gradient between the two tensiometer shafts is big enough for determining reliable unsaturated hydraulic conductivity values. After approximately two days the tension values rise with a greater slope. The measurement limit is reached about one day later. This indicates a limited and simultaneously diversified porosity. The spreading of tension values is moderate, which indicates a relatively high hydraulic conductivity in this area.

The measurement is completed by the (almost too early) failure of the upper tensiometer shaft after about three days. At this time the sample lost about 17% of the initial amount of water.

Retention curve sandy loam example:

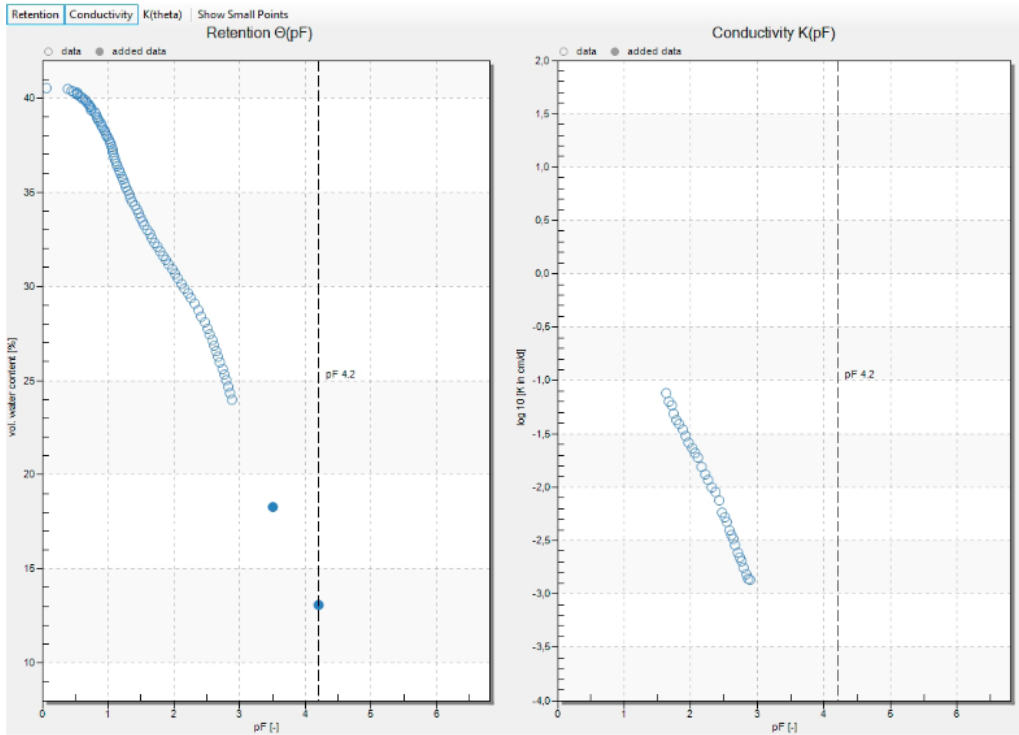
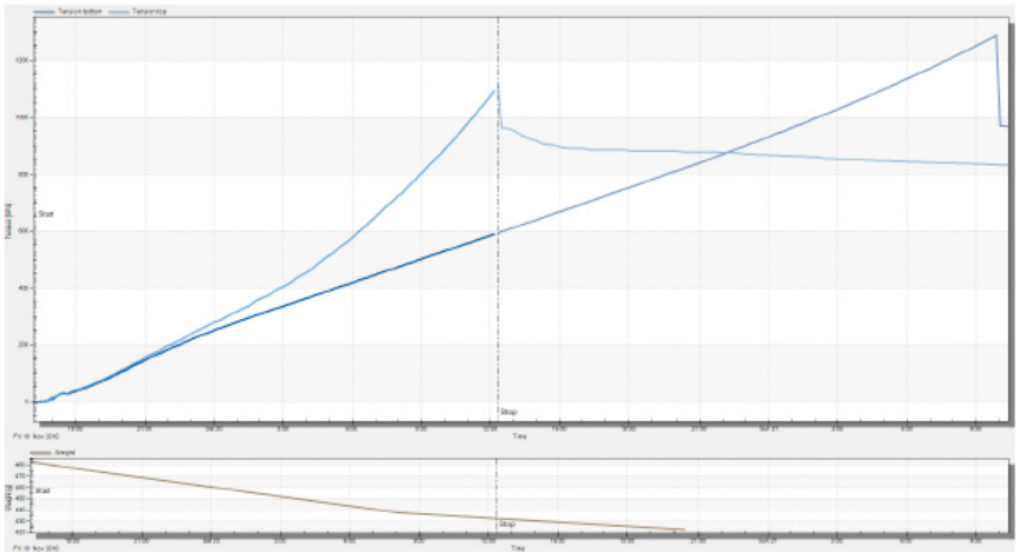

Figure 90 Example retention curve sandy loam

The relatively uniform decrease of the water content with increasing pF values and the drop of the relatively flat conductivity data is characteristic of clays having a wide pore size distribution.

The addition of the air-entry point of the ceramic tip (Power Users only) usually fits very well with the independently measured WP4C data points, and extends the range considerably. A bimodal function for fitting the data is recommended.

Example Measurement of Clayey silt (Ut3)



Site: Groß-Gleidingen near Braunschweig; soil type: clayey silt (S: 1%, U: 82%, T:17%); measurements: Praktikum Bodenphysik at TU Braunschweig, 2010. Evaporation: 14 mm/d using a fan. Temperature: 20°C

Figure 91 Example measurement clayey silt

This measurement process is typical of a very fine grained substrate. The tensions rise spontaneously, steeply, and continuously right after the start of measurement. This reflects a very small proportion of coarse pores. pF 2.0 is reached (under the given conditions with fan) after a few hours. The loss of water until pF 2 is only about 4% of the initial amount of water.

The "spikes" at the beginning of the measurement show the discontinuous access of air, penetrating into the soil. At about 100 hPa (pF 2.0), the gradient of the tensiometer values that raised parallel for the first measurement period is big enough to allow the determination of reliable hydraulic conductivity values.

Both tensiometer shafts rise unabated with time and fail relatively soon. The clayey silt has a few large middle pores. The finer middle pore region is still filled with water when the tensiometer shafts fail. The water content is therefore high.

The spread of the tension values is moderate over the entire measuring process, which indicates a relatively high unsaturated conductivity. The measurement is completed due to the failure of the upper tensiometer shaft after less than one day. At this time the sample has lost about 20% of the initial amount of water.

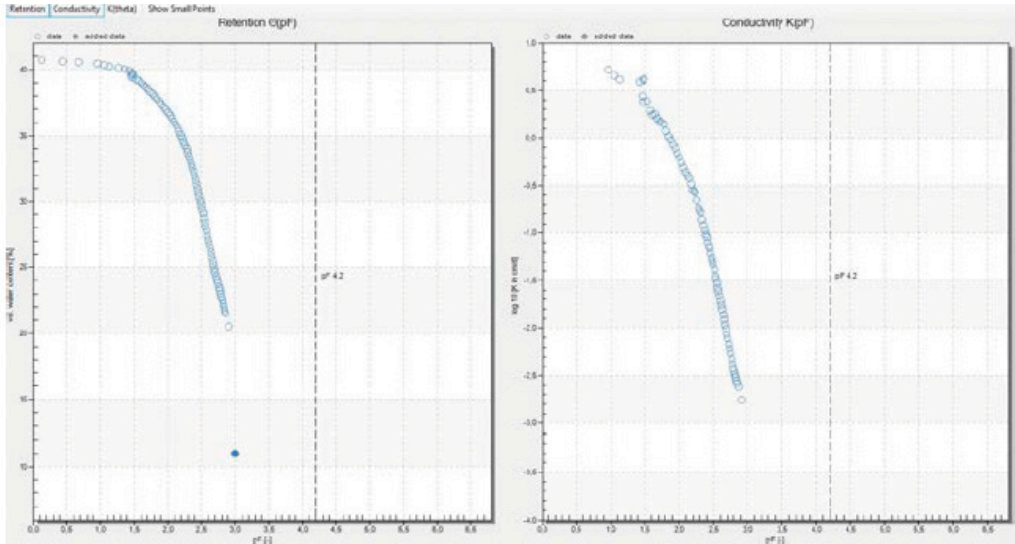
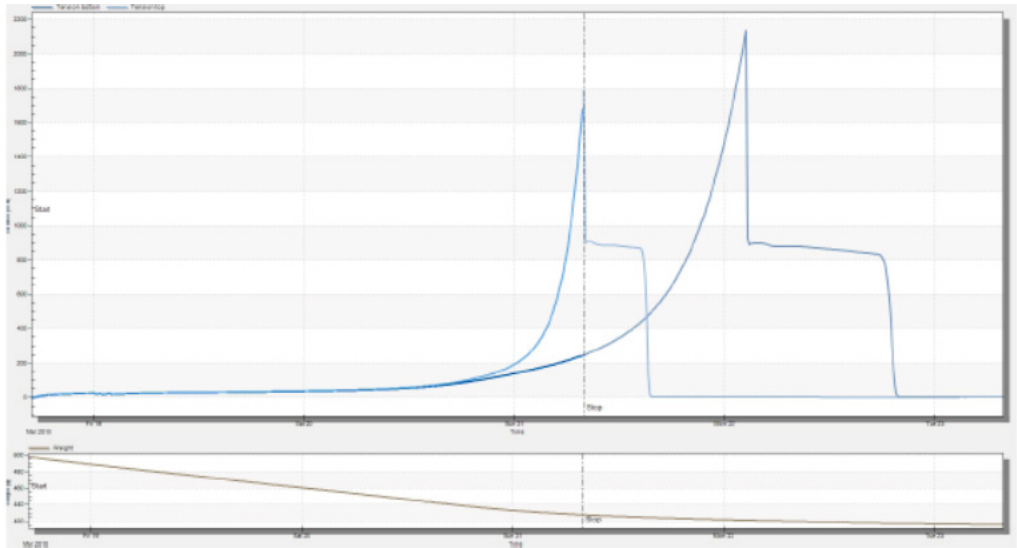

Figure 92 Example retention curve clayey silt

The drop of water content that initially is flat and then gets steeper with increasing pF values is characteristic for very fine grained and clayey substrates. The hydraulic conductivity at pF 2 is very high, but then the curve is even steeper than in the case of a clay soil.

The description of the data with models is not a problem, however in dry areas the uncertainty increases. Suitable models are the van Genuchten model, or Kosugi model.

Example Measurement Slightly loamy sand (Sl2)



Site: METER, soil type: slightly loamy sand (S: 1%, U: 82%, T: 17%), measurements at METER Soillab, Evaporation: 5.7 mm/d, temperature: 23°C

Figure 93 Example measurement slightly loamy sand

The measurement process is typical for sand with low fine pores. The tensions rise spontaneously immediately after the start of measurement until they reach a level that corresponds to the air-entry point. The tensiometer values run in parallel for a long time and differ only around a hydrostatic pressure difference of 2.5 hPa.

Only after the main pores have been drained, the upper tensiometer shaft value rises exponentially. The tensiometer shaft fails very quickly and the air-entry point of the ceramic tip is reached, while the lower tensiometer shaft is still in the regular measuring range.

Hydraulic conductivity values can only be calculated after reaching the exponential rise, as only then the difference of the tension values is big enough. The measurement is completed due to the failure of the upper tensiometer shaft after a loss of almost 30% of the initial amount of water.

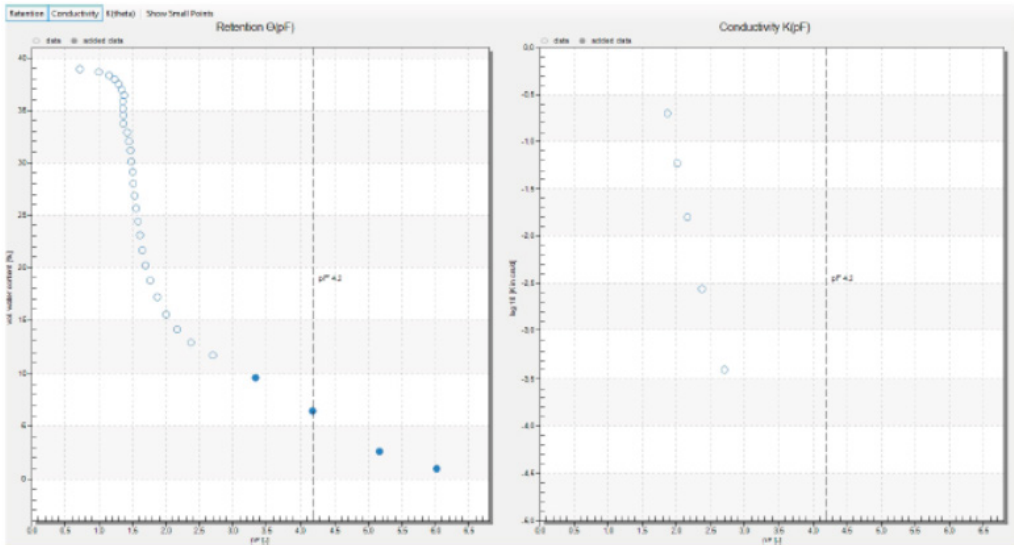

The additional data in the dry zone were measured by Lisa Heise within their thesis at TU Braunschweig /METER Munich using a device made by Decagon (WP4C). They are documented in Heise's thesis (http://www.soil.tubs.de/mitarbeiter/dipl_detail.php?id=78).

Figure 94 Example retention curve slightly loamy sand

The pronounced air-entry point and the steep drop of the retention curve after reaching the air-entry point is characteristic for sand. The hydraulic conductivity can be determined only from pF 2.0 and then drops steeply.

Suitable models for data description are the Fayer-Simmons model, or the bimodal model to describe the subsequent drop of the retention values towards dehydration.

Example Measurement Pure fine and middle sand (Ss)

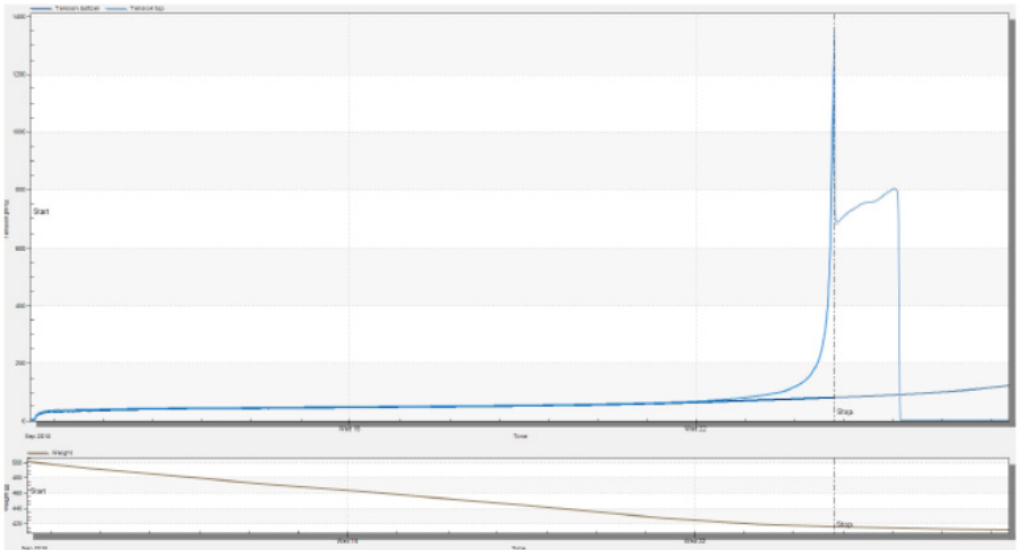

Material: packed quartz sand particle size: 0.1 bis 0.3 mm, soil type: sandy sand (S: 100%, U: 0%, T: 0%), site: Bodenphysikalisches Labor, TU Braunschweig, evaporation: 1.4 mm/d, temperature: 22°C

Figure 95 Example measurement pure fine and middle sand

The measurement process is typical for sand with a small particle size distribution and without fine pores. The tensions rise spontaneously immediately after the start of measurement until they reach a level that corresponds to the air-entry point. The tensiometer values run in parallel for a long time and differ only around a hydrostatic pressure difference of 2.5 hPa.

After draining the main pore portion the tensiometer shaft value of the upper tensiometer rises very steeply. The failure of the tensiometer shaft then occurs rapidly quick. The lower tensiometer shaft is still completely unaffected by the extreme dehydration front at the end of the measurement. The difference of the tensions is very high. Hydraulic conductivities can be calculated only for a short period of time.

The measurement is completed due to the failure of the upper tensiometer shaft after removal of 35% of the initial amount of water.

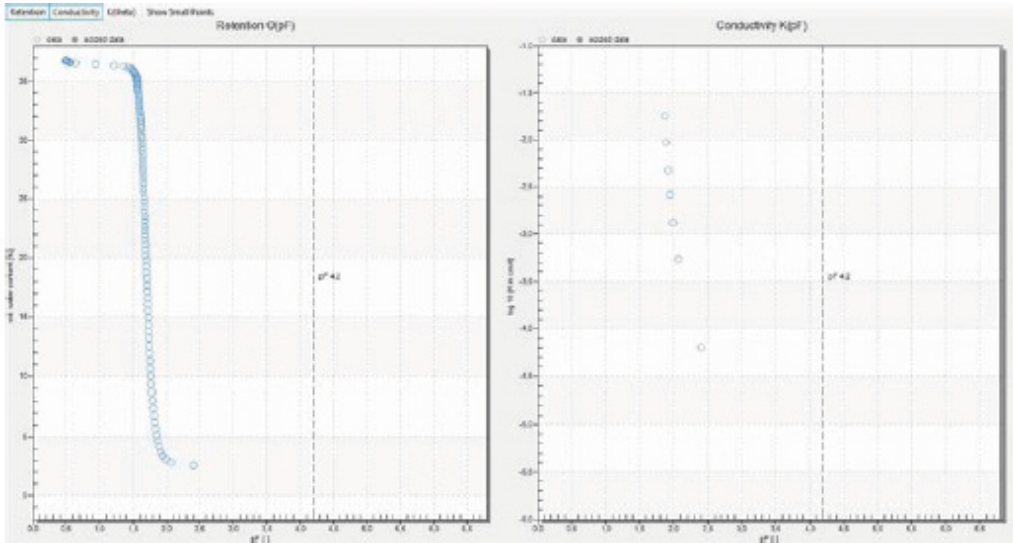

Figure 96 Example retention curve pure fine and middle sand

The very sharply defined bubble point and the extremely steep drop in the retention curve after reaching the air-entry point is characteristic of pure sand with a uniform grain size. The hydraulic conductivity can be determined only within a very narrow tension interval and drops very steeply.

Suitable models are the data description Brooks Corey model, the van Genuchten model of free parameter m or the Simmons-Fayer model.

Example pF curves

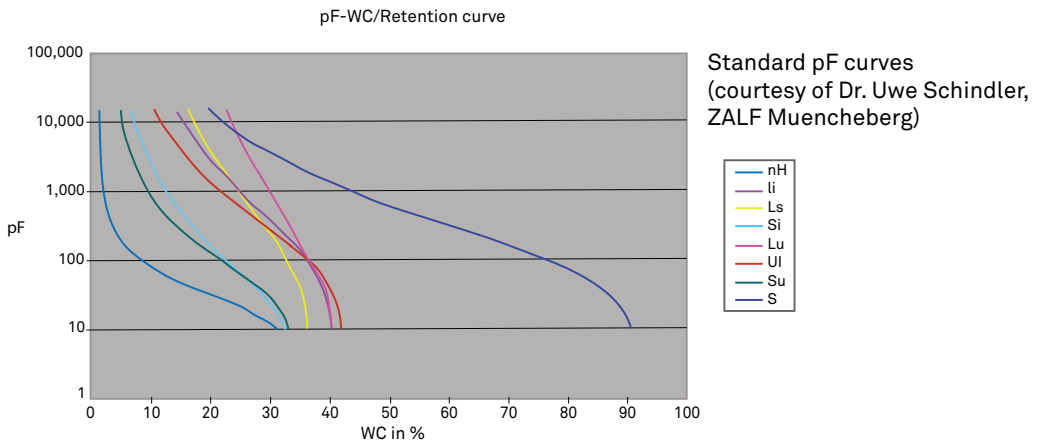

Figure 97 Standard pF curves

APPENDIX C. WP4C USE AFTER HYPROP

Procedure of sample for WP4C measurements after a HYPROP measurement.

1. Perform the HYPROP measurement until the second tensiometer shows the air-entry.

An example of this is indicated within the red-marked area in [Figure 98](#). Stopping substantially earlier may have the opposite effect. It is up to the user to determine at which suction level to obtain the data (within the acceptable area circled in red in [Figure 98](#)).

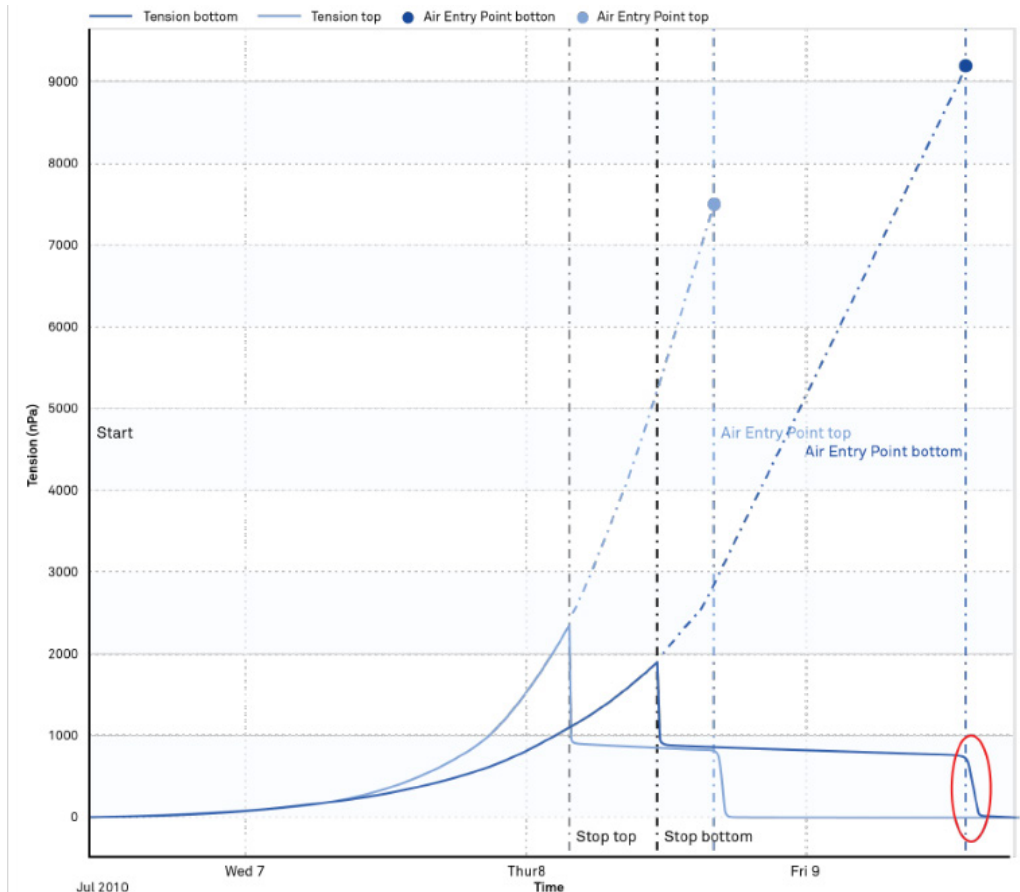

Figure 98 Perform HYPROP measurement until second tensiometer shows the **air entry**

2. After stopping the HYPROP measurement, remove the sampling ring (including the soil core) from the HYPROP device ([Figure 99](#)).

Perform all operations in a large drying pan to avoid losing any soil. In some cases, as with clay soils, it is not possible to separate the sample from the tensiometer shafts without wetting it before dismounting.

If this happens, stop the HYPROP measurement after cavitation of the top tensiometer. Or, a second option for clay samples is to use pieces of a drinking straw around the tensiometer shafts that can slide off when removing the sample.

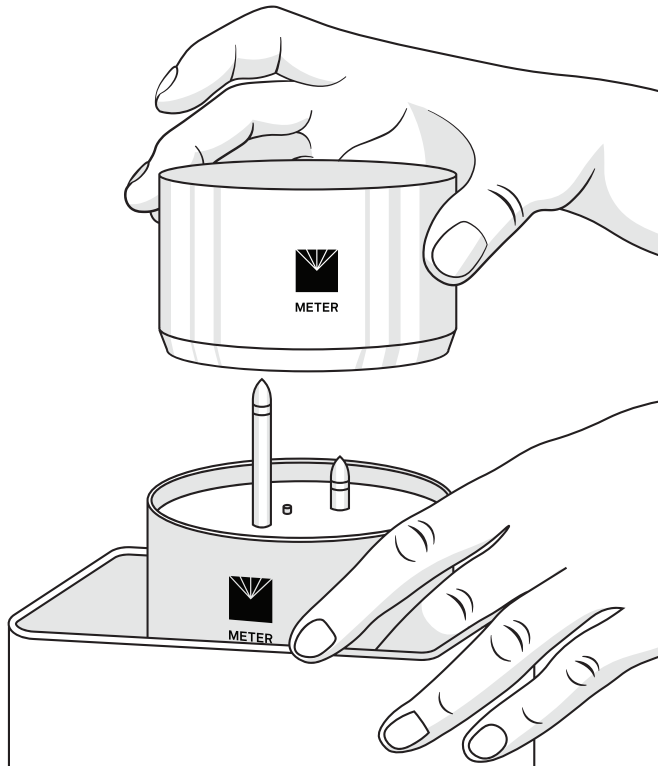

Figure 99 Remove the sample ring

NOTE: For sandy soil samples, leave the sample on the HYPROP and collect the WP4C samples while removing the soil sample in layers. Collect samples following similar methods to [step 6](#).

3. Prepare six WP4C sample cups to be filled with soil from the HYPROP core.
4. Note the tare weight of the sample cups ([Figure 100](#)).
5. Label each cup and make note of which cup is used for each sample.

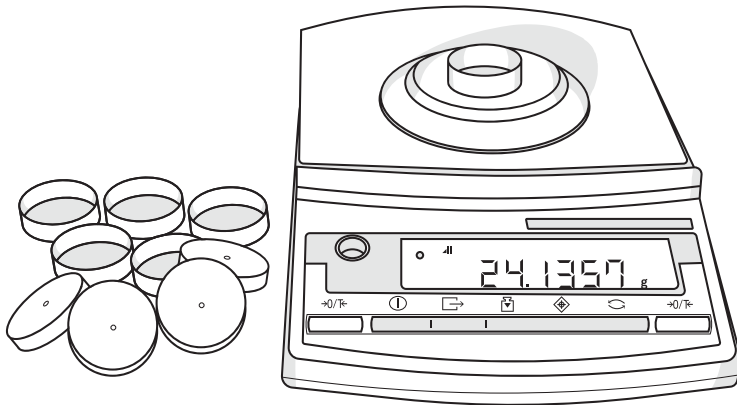

Figure 100 Document sample cup tare weight

6. Take two WP4C samples from the top of the soil core.
Use a spoon or other suitable instrument to get enough soil material to fill the first two WP4C cups half full (Figure 101).

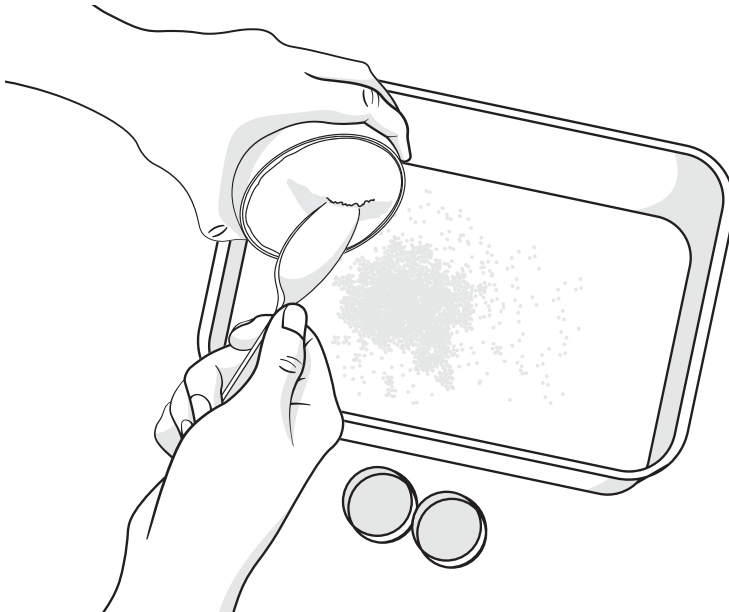

Figure 101 Collect WP4C samples

7. Turn the soil core around and repeat [step 6](#) through [step 12](#) for the next two cups.

8. Use a suitable cylinder, and press the soil column until half of the sample is out of the sampling ring.
9. Cut the sample in half with a long, sharp knife (Figure 102).
10. Take two more WP4C samples out of the middle following the procedure described in step 6.
11. Seal the samples to avoid evaporation by placing lids on the sample cup and taping the lid to the cup.
12. Allow samples to equilibrate for 24 h.

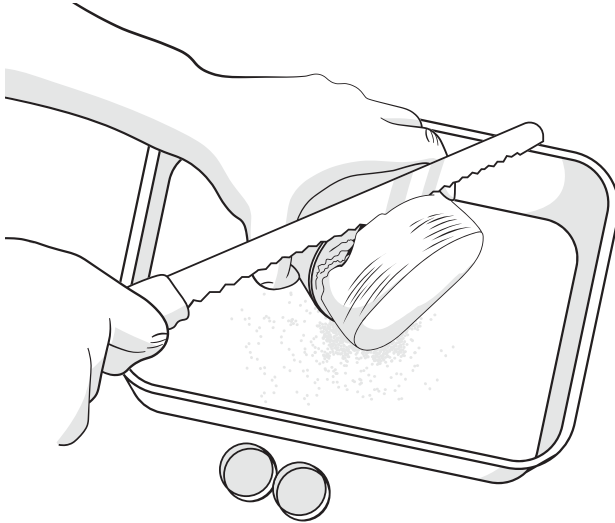

Figure 102 Cut the sample in half with long, sharp knife

NOTE: When storing the samples, leave them at room temperature to avoid condensation.

TAKING WP4C READINGS AND POSTPROCESSING

It is necessary to leave the WP4C samples in closed cups for approximately 24 hours equilibration time.

1. Carefully clean the HYPROP measuring head and place all remaining soil together into one drying pan.
2. Place the drying pan in the oven at 105 °C for 24 h to determine the dry soil weight.
3. Place the first of the six WP4C samples into the WP4C and determine the water potential as described in the [WP4C manual](http://meter.ly/wp4c-support) (meter.ly/wp4c-support).
4. Immediately after finishing the WP4C measurement, remove the sample and place it on a precision scale (accuracy of ± 0.001 g) to determine the gross weight (WP4C + cup) of the moist sample.
5. Repeat [step 2](#) through [step 4](#) for all remaining samples.

6. Dry all six samples in the drying oven at 105 °C for 24 h after measuring in the WP4C.
7. Remove the samples from the oven and let them cool down in a desiccator.
If not noted before, determine the gross weight (sample, cups, drying pan combined) and tare weights.

DATA EVALUATION WITH LABROS SOILVIEW-ANALYSIS

For data evaluation the weights for the dry soil core plus the six WP4C samples need to be combined and added to LABROS SoilView-Analysis. Insert total dry soil mass into the respective box of the LABROS SoilView-Analysis software (tab Evaluation, [Figure 103](#)).

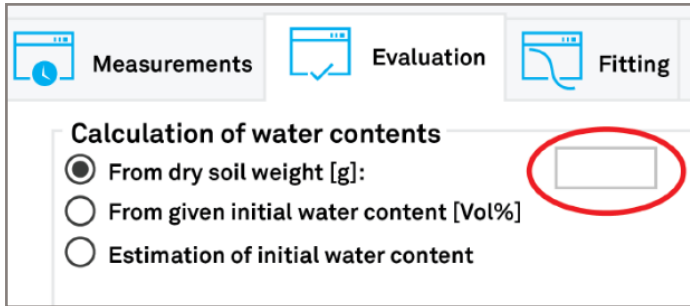

Figure 103 Insert total dry soil mass in LABROS SoilView-Analysis software

To add the WP4C data into the LABROS SoilView-Analysis software, insert the weights and MPa values (or optional pF values) for each WP4C measurement into the **Add WP4 data points** menu ([Figure 104](#)). The weighting factor is one by default. The water contents will be calculated automatically considering the bulk density of the respective HYPROP sample.

Add WP4 data points

Water potential [Mpa]	Water potential pF[-]	Gross wet mass [g]	Gross dry mass[g]	Tare mass [g]	Weighting factor	water content [Mass%]	water content [Vol%]

Figure 104 Insert the weights and Mpa values

The resulting data will be illustrated in the retention data window of LABROS SoilView-Analysis and can be fitted with a suitable parametric model.

APPENDIX D. MEASURING UNITS

Units for soil water and matrix potential.

Table A.1 Units for Soil Water and Matrix Potential

	pF	hPa	kPa=J/kg	MPa	bar	psi	%rF
	1	-10	-1	-0.001	-0.01	-0.15	99.9993
Field capacity	1.8	-62	-6.2	-0.006	-0.06	-0.89	99.998
	2	-100	-10	-0.01	-0.1	-1.45	00.9926
Standard measuring range of tensiometers	2.9	ca. 850	-85	-0.085	-0.85	-12.3	
	3	-1,000	-100	-0.1	-1	-14.5	99.9261
	4	-10,000	-1,000	-1.0	-10	-145.0	99.2638
Permanent wilting point	4.2	-15,000	-1,500	-1.5	-15	-219.5	98.8977
	5	-1000,000	-10,000	-10	-100	-1450.4	92.8772
Air dry, depending on air humidity	6	-1,000,000	-1000,000	-100	-1,000	-1450.4	47.7632
Oven dry	7	-10,000,000	-1,000,000	-1,000	-10,000	-1450.38	0.0618

NOTE: 0.981 kPa corresponds to 10 cm water column

REFERENCES

- Brooks, R. H. and Corey, A. T. (1964): Hydraulic properties of porous media. Hydrology Paper 3. Colorado State University, Fort Collins, Colorado.
- Fredlund, D. G., & Xing, A. (1994): Equations for the soil-water characteristic curve. Canadian geotechnical journal, 31(4), 521–532.
- Iden, S.C., and W. Durner (2014): Comment to “Simple consistent models for water retention and hydraulic conductivity in the complete moisture range” by A. Peters., Water Resour. Res., 50, 7530–7534.
- Kosugi, K. I. (1996): Lognormal distribution model for unsaturated soil hydraulic properties. Water Resources Research, 32(9), 2697–2703.
- Peters, A. and Durner, W. (2006): Improved estimation of soil water retention characteristics from hydrostatic column experiments. Water Resources Research 42 (11).
- Peters, A. and Durner, W. (2008): Simplified Evaporation Method for Determining Soil Hydraulic Properties. Journal of Hydrology 356 (1–2): 147–162.
- Peters, A. and Durner, W. (2007): Optimierung eines einfachen Verdunstungsverfahrens zur Bestimmung bodenhydraulischer Eigenschaften. Mitteilungen der Deutschen Bodenkundlichen Gesellschaft 110 (1): 125–126.
- Peters, A. (2013): Simple consistent models for water retention and hydraulic conductivity in the complete moisture range, Water Resour..Res., 49, 6765–6780.
- Peters, A., S.C. Iden, and W. Durner (2015): Revisiting the simplified evaporation method: Identification of hydraulic functions considering vapor, film and corner flow. Journal of Hydrology, in press.
- Schelle, H., Iden, S. C., Peters, A. and Durner, W. (2010): Analysis of the agreement of soil hydraulic properties obtained from multistep-outflow and evaporation methods. Vadose Zone Journal 9 (4): 1080–1091.
- Schelle, H., Iden, S. C. and Durner, W. (2011): Combined transient method for determining soil hydraulic properties in a wide pressure head range. Soil Science Society of America Journal 75(5): 1–13.
- Schelle, H., Heise, L., Jänicke, K. and Durner, W. (2013a): Wasserretentionseigenschaften von Böden über den gesamten Feuchtebereich - ein Methodenvergleich. - In: Beiträge zur 15. Lysimetertagung am 16. and 17. April 2013, HBFLA Raumberg-Gumpenstein.
- Schelle, H., Heise, L., Jänicke, K. and Durner, W. (2013b): Water retention characteristics of soils over the whole moisture range: a comparison of laboratory methods. European Journal of Soil Science 64 (6): 814–821.

REFERENCES

- Schindler, U. (1980): Ein Schnellverfahren zur Messung der Wasserleitfähigkeit im teilgesättigten Boden an Stechzylinderproben. *Archiv für Acker- und Pflanzenbau und Bodenkunde* 24 (1): 1–7.
- Schindler, U. and Müller, L. (2006): Simplifying the evaporation method for quantifying soil hydraulic properties. *Journal of Plant Nutrition and Soil Science* 169 (5): 623–629.
- Schindler, U., Durner, W., von Unold, G. and Müller, L. (2010a): Evaporation method for measuring unsaturated hydraulic properties of soils: Extending the measurement range. *Soil Science Society of America Journal* 74 (4): 1071–1083.
- Schindler, U., Durner, W., von Unold, G., Müller, L. and Wieland, R. (2010b): The evaporation method: Extending the measurement range of soil hydraulic properties using the air entry pressure of the ceramic cup. *Journal of Plant Nutrition and Soil Science* 173 (4): 563–572.
- Schindler, U., Doerner, J. and Müller, L. (2015): Simplified method for quantifying the hydraulic properties of shrinking soils. *Journal of Plant Nutrition and Soil Science* 178 (1): 136–145.
- METER (2022): LABROS SoilView-Analysis for HYPROP Manual. METER Group AG Mettlacher Straße 8, 81379 München, Germany, 2022. URL www.metergroup.com/hyprop-2/#support
- Van Genuchten, M. T. (1980): A closed-form equation for predicting the hydraulic conductivity of unsaturated soils. *Soil Science Society of America Journal* 44: 892–898.
- Wind, G.P. (1968): Capillary conductivity data estimated by a simple method. p.181–191. In R.E. Rijtema and H. Wassink (ed.) *Water in the Unsaturated Zone: Proc. UNESCO/IASH Symp., Wageningen, the Netherlands.*

INDEX

- A**
- air entry point **82**
 - determining air entry value **89**
 - finishing a measurement options **62–65**
 - phase 4 **59–60**
- B**
- boiling delay **59**
- C**
- calibration
 - LABROS Balance calibration **43**
 - offset recalibration **31**
 - sensor calibration scheduler **84**
 - cleaning **66, 84**
 - compliance **71**
 - components **71**
 - configuration **55**
 - contents
 - HYPROP complete set **1**
 - HYPROP extension set **2**
 - HYPROP starter set **2**
 - customer support **88**
- D**
- data evaluation **68**
 - degassing
 - with syringes **18–30**
 - with vacuum pump **16–18**
- E**
- email address **88**. *See* customer support
- F**
- fax number **88**
- M**
- maintenance **84**. *See also* cleaning
 - measurements **69–71**
 - continue stopped or completed **76**
 - measurement range **65**
 - See* specifications
 - multi-balance measurement mode **45**
 - optimal measurement curve **59**
 - single-balance mode **50**
 - suboptimal measurement curve **60**
- P**
- phone number **88**
 - postprocessing **65**
 - determining dry soil weight **65**
 - preparation **16**. *See also* tensiometer, filling
 - offset recalibration **31**
 - refilling the sensor unit **16**
 - sensor assembly **41**
- R**
- references **106**
 - refill wizard. *See* preparation
- S**
- service **84**
 - calibration **84**
 - cleaning and maintenance **84**
 - customer support **88**

specifications **69–72**
 communication **69**
 measurement **69**
 physical **70**

T

tensiometer **16, 39, 41, 42**
 filling **16**
 installation **34**

terms and conditions **88–107**

theory **77–83**
 generating data points **80**
 measuring method **78**

troubleshooting **86**

METER Group, Inc.

2365 NE Hopkins Court Pullman, WA 99163

T: +1.509.332.2756 F: +1.509.332.5158

E: info@metergroup.com W: metergroup.com

METER Group GmbH

Mettlacher Straße 8, 81379 München

T: +49 89 1266520 F: +49 89 12665220

E: info.europe@metergroup.com W: metergroup.de

